

**Metallized Polypropylene
film capacitors**

PCMP 389

MKP RADIAL POTTED CAPACITORS

Pitch 10.0/15.0/22.5/27.5mm
(reduced pitch 7.5mm)

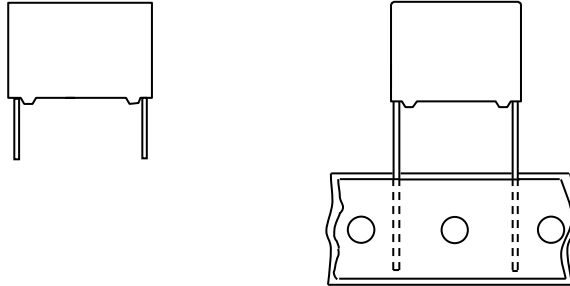

QUICK REFERENCE DATA

Capacitance range (E24 series)	0.00082 to 3.9 μ F
Capacitance tolerance	\pm 5%
Rated voltage (DC)	250V, 400V, 630V, 1000V, 1250V, 1600V, 2000V
Climatic category	55/105/56
Temperature range	-55 $^{\circ}$ C ~ +105 $^{\circ}$ C
Reference specification	IEC 60384-17 / 16
Potting & Encapsulation material	Qualified in accordance with UL94V-0

FEATURES	APPLICATIONS
<ul style="list-style-type: none"> . 15mm to 27.5mm lead pitch . Low contact resistance . Low loss dielectric . Small dimensions for high density packaging . Supplied loose in box and taped on reel . High pulse withstand capability (1600V, 2000V) 	<ul style="list-style-type: none"> . Where steep pulses occur e.g. SMPS (switch mode power supplies) . S - correction . Motor control circuits . Electronic lighting circuits (1600V, 2000V) . Stable capacitance in damp environment 85$^{\circ}$C85%RH, V_{Rdc}, 500hours

• Design and specifications are subjected to change without notice. Please refer to caution and warning at <http://www.pilkor.co.kr/sub/download/Introductions.pdf> before using these products.

Metallized Polypropylene film capacitors

PCMP 389

Ordering Information

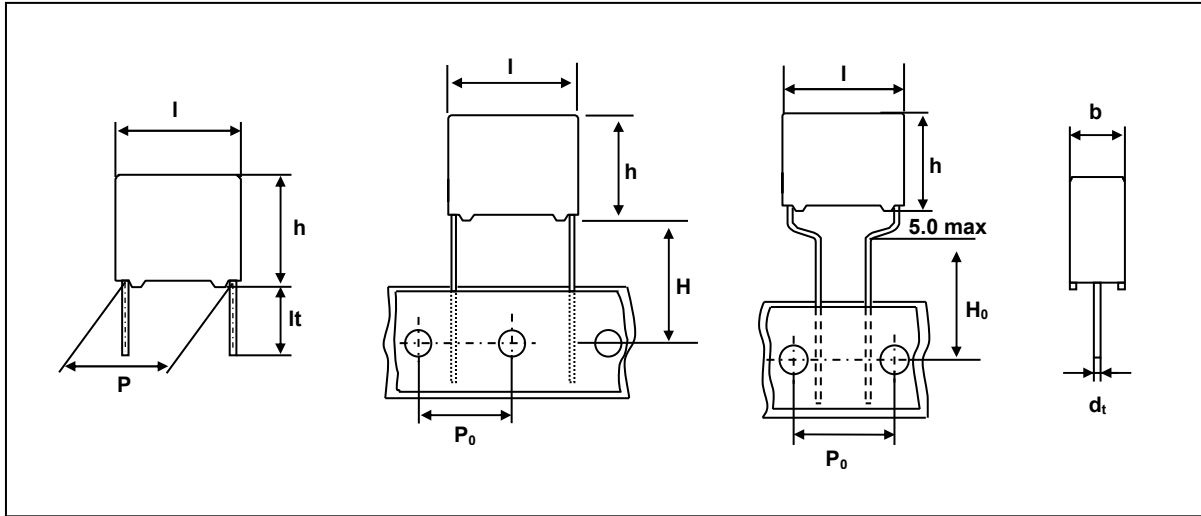

PCMP 389 (X) X X XXX
 Type series Capacitance

Code	Voltage
4	250V
5	400V
6	630V
7	1000V
N	1250V
8	1600V
9	2000V

*Code	Original pitch
D	10.0mm
F	15.0mm
J	22.5mm
L	27.5mm

** In case of overlapping the value, use the 13NC with pitch information.*

Available versions					Product (I _{max})			
Code	Packing method	C-tol.	Lead length & Height	Hole to hole (P ₀)	12.5	18.0	26.0	31.0
					Pitch (P)			
2	Loose in box	± 5%	lt = 5.0± 1.0mm	-	10.0	15.0	22.5	27.5
3	Loose in box	± 5%	lt =25.0± 2.0mm	-	10.0	15.0	22.5	27.5
5	Ammo packing	± 5%	H=18.5mm	12.7mm	10.0	15.0	22.5	27.5
A	Ammo packing	± 5%	H ₀ =16.0mm	15.0mm	7.5(*)	7.5(*)	-	-

* Reduced pitch (Reduced lead spacings)

Metallized Polypropylene film capacitors

PCMP 389

Packing Information

SMALLEST PACKING QUANTITIES (SPQ)	Loose in box	Ammo packing
	It = 5.0±1.0mm	H=18.5mm
DIMENSIONS	SPQ	SPQ
4.0 x 10.0 x 12.5	2000	800
5.0 x 11.0 x 12.5	1500	700
6.0 x 12.0 x 12.5	1000	600
5.0 x 11.0 x 18.0	1000	700
6.0 x 12.0 x 18.0	1000	600
7.0 x 13.5 x 18.0	1000	500
8.5 x 15.0 x 18.0	1000	400
10.0 x 16.5 x 18.0	1000	370
11.0 x 18.5 x 18.0	1000	330
6.0 x 15.5 x 26.0	1000	600
7.0 x 16.5 x 26.0	1000	500
8.5 x 18.0 x 26.0	500	400
10.0 x 19.5 x 26.0	500	370
11.5 x 21.0 x 26.0	500	300
12.0 x 22.0 x 26.0	500	300
11.0 x 21.0 x 31.0	500	300
13.0 x 23.0 x 31.0	250	250
15.0 x 25.0 x 31.0	250	220
18.0 x 28.0 x 31.0	200	200

Metallized Polypropylene film capacitors

PCMP 389

 $V_{Rdc} = 250 V$
 $V_{Rac} = 160 V\sim$

Cap (μF)	b x h x l (mm)	Mass (g)	CATALOGUE NUMBER		
			PCMP 389		
			loose in box	ammo packing	
			lt = 5.0 \pm 1.0 mm	H = 18.5 mm	
		C - tol. \pm 5%		C - tol. \pm 5%	
Pitch = 10.0 \pm 0.4 mm			dt = 0.6 mm (+ 0.06 / - 0.05)		
0.047 0.051 0.056 0.062 0.068	4.0 x 10.0 x 12.5	0.8	PCMP 389 42473 PCMP 389 42513 PCMP 389 42563 PCMP 389 42623 PCMP 389 42683	PCMP 389 45473 PCMP 389 45513 PCMP 389 45563 PCMP 389 45623 PCMP 389 45683	
0.075 0.082 0.091	5.0 x 11.0 x 12.5	0.9	PCMP 389 42753 PCMP 389 42823 PCMP 389 42913	PCMP 389 45753 PCMP 389 45823 PCMP 389 45913	
0.10 0.11 0.12	6.0 x 12.0 x 12.5	1.0	PCMP 389 42104 PCMP 389 42114 PCMP 389 42124	PCMP 389 45104 PCMP 389 45114 PCMP 389 45124	
Pitch = 15.0 \pm 0.4 mm			dt = 0.8 mm (+ 0.08 / - 0.05)		
0.10 0.11 0.12 0.13 0.15 0.16	5.0 x 11.0 x 18.0	1.2	PCMP 389F42104 PCMP 389F42114 PCMP 389F42124 PCMP 389 42134 PCMP 389 42154 PCMP 389 42164	PCMP 389F45104 PCMP 389F45114 PCMP 389F45124 PCMP 389 45134 PCMP 389 45154 PCMP 389 45164	
0.18 0.20 0.22 0.24 0.33 0.36 0.39	6.0 x 12.0 x 18.0	1.4	PCMP 389 42184 PCMP 389 42204 PCMP 389 42224 PCMP 389 42244 PCMP 389F42334 PCMP 389F42364 PCMP 389F42394	PCMP 389 45184 PCMP 389 45204 PCMP 389 45224 PCMP 389 45244 PCMP 389F45334 PCMP 389F45364 PCMP 389F45394	
0.27 0.30 0.33 0.43 0.47	7.0 x 13.5 x 18.0	1.9	PCMP 389 42274 PCMP 389 42304 PCMP 389 42334 PCMP 389F42434 PCMP 389F42474	PCMP 389 45274 PCMP 389 45304 PCMP 389 45334 PCMP 389F45434 PCMP 389F45474	
0.36 0.39 0.43 0.47	8.5 x 15.0 x 18.0	2.6	PCMP 389 42364 PCMP 389 42394 PCMP 389 42434 PCMP 389 42474	PCMP 389 45364 PCMP 389 45394 PCMP 389 45434 PCMP 389 45474	

Metallized Polypropylene film capacitors

PCMP 389

 $V_{Rdc} = 250 V$ $V_{Rac} = 160 V$

Cap (μF)	b x h x l (mm)	Mass (g)	CATALOGUE NUMBER		
			PCMP 389		
			loose in box	ammo packing	
			lt = 5.0 \pm 1.0 mm	H = 18.5 mm	
		C - tol. \pm 5%		C - tol. \pm 5%	
Pitch = 22.5 \pm 0.4 mm			dt = 0.8 mm (+ 0.08 / - 0.05)		
0.33	7.0 X 16.5 X 26.0	3.1	PCMP 389J42334	PCMP 389J45334	
0.36			PCMP 389J42364	PCMP 389J45364	
0.39			PCMP 389J42394	PCMP 389J45394	
0.43			PCMP 389J42434	PCMP 389J45434	
0.47			PCMP 389J42474	PCMP 389J45474	
0.51			PCMP 389 42514	PCMP 389 45514	
0.56			PCMP 389 42564	PCMP 389 45564	
0.62			PCMP 389 42624	PCMP 389 45624	
0.75			PCMP 389J42754	PCMP 389J45754	
0.82			PCMP 389J42824	PCMP 389J45824	
0.91			PCMP 389J42914	PCMP 389J45914	
1.0	PCMP 389J42105	PCMP 389J45105			
0.68	8.5 X 18.0 X 26.0	4.4	PCMP 389 42684	PCMP 389 45684	
0.75			PCMP 389 42754	PCMP 389 45754	
0.82			PCMP 389 42824	PCMP 389 45824	
0.91			PCMP 389 42914	PCMP 389 45914	
1.1			PCMP 389J42115	PCMP 389J45115	
1.2			PCMP 389J42125	PCMP 389J45125	
1.0	10.0 X 19.5 X 26.0	5.5	PCMP 389 42105	PCMP 389 45105	
1.1			PCMP 389 42115	PCMP 389 45115	
1.2			PCMP 389 42125	PCMP 389 45125	
Pitch = 27.5 \pm 0.4 mm			dt = 0.8 mm (+ 0.08 / - 0.05)		
0.91	11.0 X 21.0 X 31.0	8.2	PCMP 389L42914	-	
1.0			PCMP 389L42105	-	
1.1			PCMP 389L42115	-	
1.2			PCMP 389L42125	-	
1.3			PCMP 389 42135	-	
1.5			PCMP 389 42155	-	
1.6			PCMP 389 42165	-	
1.8	13.0 X 23.0 X 31.0	10.4	PCMP 389 42185	-	
2.0			PCMP 389 42205	-	
2.2			PCMP 389 42225	-	
2.4	15.0 X 25.0 X 31.0	12.8	PCMP 389 42245	-	
2.7			PCMP 389 42275	-	
3.0	18.0 X 28.0 X 31.0	17.2	PCMP 389 42305	-	
3.3			PCMP 389 42335	-	
3.6			PCMP 389 42365	-	
3.9			PCMP 389 42395	-	

Metallized Polypropylene film capacitors

PCMP 389

 $V_{Rdc} = 400\text{ V}$ $V_{Rac} = 200\text{ V}$

Cap (μF)	b x h x l (mm)	Mass (g)	CATALOGUE NUMBER	
			PCMP 389	
			loose in box	ammo packing
			lt = 5.0 \pm 1.0 mm	H = 18.5 mm
			C - tol. \pm 5%	C - tol. \pm 5%
Pitch = 10.0 \pm 0.4 mm			dt = 0.6 mm (+ 0.06 / - 0.05)	
0.022 0.024 0.027 0.030 0.033	4.0 x 10.0 x 12.5	0.8	PCMP 389 52223 PCMP 389 52243 PCMP 389 52273 PCMP 389 52303 PCMP 389 52333	PCMP 389 55223 PCMP 389 55243 PCMP 389 55273 PCMP 389 55303 PCMP 389 55333
0.036 0.039 0.043 0.047	5.0 x 11.0 x 12.5	0.9	PCMP 389 52363 PCMP 389 52393 PCMP 389 52433 PCMP 389 52473	PCMP 389 55363 PCMP 389 55393 PCMP 389 55433 PCMP 389 55473
0.051 0.056	6.0 x 12.0 x 12.5	1.0	PCMP 389 52513 PCMP 389 52563	PCMP 389 55513 PCMP 389 55563
Pitch = 15.0 \pm 0.4 mm			dt = 0.8 mm (+ 0.08 / - 0.05)	
0.047 0.051 0.056 0.062 0.068 0.075 0.082	5.0 x 11.0 x 18.0	1.2	PCMP 389F52473 PCMP 389F52513 PCMP 389F52563 PCMP 389 52623 PCMP 389 52683 PCMP 389 52753 PCMP 389 52823	PCMP 389F55473 PCMP 389F55513 PCMP 389F55563 PCMP 389 55623 PCMP 389 55683 PCMP 389 55753 PCMP 389 55823
0.091 0.10 0.11 0.12 0.13 0.15 0.16	6.0 x 12.0 x 18.0	1.4	PCMP 389 52913 PCMP 389 52104 PCMP 389 52114 PCMP 389 52124 PCMP 389F52134 PCMP 389F52154 PCMP 389F52164	PCMP 389 55913 PCMP 389 55104 PCMP 389 55114 PCMP 389 55124 PCMP 389F55134 PCMP 389F55154 PCMP 389F55164
0.13 0.15 0.16 0.18 0.20 0.22	7.0 x 13.5 x 18.0	1.9	PCMP 389 52134 PCMP 389 52154 PCMP 389 52164 PCMP 389F52184 PCMP 389F52204 PCMP 389F52224	PCMP 389 55134 PCMP 389 55154 PCMP 389 55164 PCMP 389F55184 PCMP 389F55204 PCMP 389F55224
0.18 0.20 0.22	8.5 x 15.0 x 18.0	2.6	PCMP 389 52184 PCMP 389 52204 PCMP 389 52224	PCMP 389 55184 PCMP 389 55204 PCMP 389 55224

**Metallized Polypropylene
film capacitors**

PCMP 389

$V_{Rdc} = 400 V$

$V_{Rac} = 200 V$

Cap (μF)	b x h x l (mm)	Mass (g)	CATALOGUE NUMBER	
			PCMP 389	
			loose in box	ammo packing
			lt = 5.0 \pm 1.0 mm	H = 18.5 mm
			C - tol. \pm 5%	C - tol. \pm 5%
Pitch = 22.5 \pm 0.4 mm			dt = 0.8 mm (+ 0.08 / - 0.05)	
0.18 0.20 0.22 0.24 0.27 0.30 0.33 0.36 0.39	7.0 X 16.5 X 26.0	3.1	PCMP 389J52184 PCMP 389J52204 PCMP 389J52224 PCMP 389 52244 PCMP 389 52274 PCMP 389 52304 PCMP 389J52334 PCMP 389J52364 PCMP 389J52394	PCMP 389J55184 PCMP 389J55204 PCMP 389J55224 PCMP 389 55244 PCMP 389 55274 PCMP 389 55304 PCMP 389J55334 PCMP 389J55364 PCMP 389J55394
0.33 0.36 0.39 0.43 0.47 0.51 0.56 0.62	8.5 X 18.0 X 26.0	4.4	PCMP 389 52334 PCMP 389 52364 PCMP 389 52394 PCMP 389 52434 PCMP 389 52474 PCMP 389J52514 PCMP 389J52564 PCMP 389J52624	PCMP 389 55334 PCMP 389 55364 PCMP 389 55394 PCMP 389 55434 PCMP 389 55474 PCMP 389J55514 PCMP 389J55564 PCMP 389J55624
0.51 0.56 0.62	10.0 X 19.5 X 26.0	5.5	PCMP 389 52514 PCMP 389 52564 PCMP 389 52624	PCMP 389 55514 PCMP 389 55564 PCMP 389 55624
Pitch = 27.5 \pm 0.4 mm			dt = 0.8 mm (+ 0.08 / - 0.05)	
0.51 0.56 0.62 0.68 0.75 0.82	11.0 X 21.0 X 31.0	8.2	PCMP 389L52514 PCMP 389L52564 PCMP 389L52624 PCMP 389 52684 PCMP 389 52754 PCMP 389 52824	- - - - - -
0.91 1.0 1.1	13.0 X 23.0 X 31.0	10.4	PCMP 389 52914 PCMP 389 52105 PCMP 389 52115	- - -
1.2 1.3 1.5	15.0 X 25.0 X 31.0	12.8	PCMP 389 52125 PCMP 389 52135 PCMP 389 52155	- - -
1.6 1.8 2.0	18.0 X 28.0 X 31.0	17.2	PCMP 389 52165 PCMP 389 52185 PCMP 389 52205	- - -

Metallized Polypropylene film capacitors

PCMP 389

 $V_{Rdc} = 630 V$ $V_{Rac} = 250 V\sim$

Cap (μF)	b x h x l (mm)	Mass (g)	CATALOGUE NUMBER	
			PCMP 389	
			loose in box	ammo packing
			lt = 5.0 \pm 1.0 mm	H = 18.5 mm
			C - tol. \pm 5%	C - tol. \pm 5%
Pitch = 10.0 \pm 0.4 mm			dt = 0.6 mm (+ 0.06 / - 0.05)	
0.010 0.011 0.012 0.013 0.015 0.016	4.0 x 10.0 x 12.5	0.8	PCMP 389 62103 PCMP 389 62113 PCMP 389 62123 PCMP 389 62133 PCMP 389 62153 PCMP 389 62163	PCMP 389 65103 PCMP 389 65113 PCMP 389 65123 PCMP 389 65133 PCMP 389 65153 PCMP 389 65163
0.018 0.020 0.022 0.024	5.0 x 11.0 x 12.5	0.9	PCMP 389 62183 PCMP 389 62203 PCMP 389 62223 PCMP 389 62243	PCMP 389 65183 PCMP 389 65203 PCMP 389 65223 PCMP 389 65243
0.027 0.030 0.033	6.0 x 12.0 x 12.5	1.0	PCMP 389 62273 PCMP 389 62303 PCMP 389 62333	PCMP 389 65273 PCMP 389 65303 PCMP 389 65333
Pitch = 15.0 \pm 0.4 mm			dt = 0.8 mm (+ 0.08 / - 0.05)	
0.027 0.030 0.033 0.036 0.039	5.0 X 11.0 X 18.0	1.2	PCMP 389F62273 PCMP 389F62303 PCMP 389F62333 PCMP 389 62363 PCMP 389 62393	PCMP 389F65273 PCMP 389F65303 PCMP 389F65333 PCMP 389 65363 PCMP 389 65393
0.043 0.047 0.051 0.056 0.062 0.068	6.0 X 12.0 X 18.0	1.4	PCMP 389 62433 PCMP 389 62473 PCMP 389 62513 PCMP 389 62563 PCMP 389 62623 PCMP 389F62683	PCMP 389 65433 PCMP 389 65473 PCMP 389 65513 PCMP 389 65563 PCMP 389 65623 PCMP 389F65683
0.068 0.075 0.082 0.091	7.0 X 13.5 X 18.0	1.9	PCMP 389 62683 PCMP 389 62753 PCMP 389 62823 PCMP 389F62913	PCMP 389 65683 PCMP 389 65753 PCMP 389 65823 PCMP 389F65913
0.091 0.10 0.11	8.5 X 15.0 X 18.0	2.6	PCMP 389 62913 PCMP 389 62104 PCMP 389 62114	PCMP 389 65913 PCMP 389 65104 PCMP 389 65114

Metallized Polypropylene film capacitors

PCMP 389

 $V_{Rdc} = 630 V$ $V_{Rac} = 250 V\sim$

Cap (μF)	b x h x l (mm)	Mass (g)	CATALOGUE NUMBER	
			PCMP 389	
			loose in box	ammo packing
			lt = 5.0 \pm 1.0 mm	H = 18.5 mm
			C - tol. \pm 5%	C - tol. \pm 5%
Pitch = 22.5 \pm 0.4 mm			dt = 0.8 mm (+ 0.08 / - 0.05)	
0.10 0.11 0.12 0.13 0.15 0.16	7.0 X 16.5 X 26.0	3.1	PCMP 389J62104 PCMP 389J62114 PCMP 389 62124 PCMP 389 62134 PCMP 389 62154 PCMP 389 62164	PCMP 389J65104 PCMP 389J65114 PCMP 389 65124 PCMP 389 65134 PCMP 389 65154 PCMP 389 65164
0.18 0.20 0.22 0.24 0.27	8.5 X 18.0 X 26.0	4.4	PCMP 389 62184 PCMP 389 62204 PCMP 389 62224 PCMP 389J62244 PCMP 389J62274	PCMP 389 65184 PCMP 389 65204 PCMP 389 65224 PCMP 389J65244 PCMP 389J65274
0.24 0.27 0.30	10.0 X 19.5 X 26.0	5.5	PCMP 389 62244 PCMP 389 62274 PCMP 389 62304	PCMP 389 65244 PCMP 389 65274 PCMP 389 65304
Pitch = 27.5 \pm 0.4 mm			dt = 0.8 mm (+ 0.08 / - 0.05)	
0.22 0.24 0.27 0.30 0.33 0.36 0.39 0.43	11.0 X 21.0 X 31.0	8.2	PCMP 389L62224 PCMP 389L62244 PCMP 389L62274 PCMP 389L62304 PCMP 389 62334 PCMP 389 62364 PCMP 389 62394 PCMP 389 62434	- - - - - - - -
0.47 0.51 0.56	13.0 X 23.0 X 31.0	10.4	PCMP 389 62474 PCMP 389 62514 PCMP 389 62564	- - -
0.62 0.68 0.75 0.82	15.0 X 25.0 X 31.0	12.8	PCMP 389 62624 PCMP 389 62684 PCMP 389 62754 PCMP 389 62824	- - - -
0.91 1.0	18.0 X 28.0 X 31.0	17.2	PCMP 389 62914 PCMP 389 62105	- -

Metallized Polypropylene film capacitors

PCMP 389

 $V_{Rdc} = 1000\text{ V}$
 $V_{Rac} = 400\text{ V}^{-}$

Cap (μF)	b x h x l (mm)	Mass (g)	CATALOGUE NUMBER	
			PCMP 389	
			loose in box	ammo packing
			lt = 5 ± 1 mm	H = 18.5 mm
			C - tol. $\pm 5\%$	C - tol. $\pm 5\%$
Pitch = 10.0 ± 0.4 mm			dt = 0.6 mm (+ 0.06 / - 0.05)	
0.0020 0.0022 0.0024 0.0027 0.0030 0.0033 0.0036 0.0039 0.0043 0.0047 0.0051 0.0056 0.0062 0.0068 0.0075 0.0082	5.0 x 11.0 x 12.5	0.9	PCMP 389 72202 PCMP 389 72222 PCMP 389 72242 PCMP 389 72272 PCMP 389 72302 PCMP 389 72332 PCMP 389 72362 PCMP 389 72392 PCMP 389 72432 PCMP 389 72472 PCMP 389 72512 PCMP 389 72562 PCMP 389 72622 PCMP 389 72682 PCMP 389 72752 PCMP 389 72822	PCMP 389 75202 PCMP 389 75222 PCMP 389 75242 PCMP 389 75272 PCMP 389 75302 PCMP 389 75332 PCMP 389 75362 PCMP 389 75392 PCMP 389 75432 PCMP 389 75472 PCMP 389 75512 PCMP 389 75562 PCMP 389 75622 PCMP 389 75682 PCMP 389 75752 PCMP 389 75822
0.0091 0.010 0.011 0.012	6.0 x 12.0 x 12.5	1.0	PCMP 389 72912 PCMP 389 72103 PCMP 389 72113 PCMP 389 72123	PCMP 389 75912 PCMP 389 75103 PCMP 389 75113 PCMP 389 75123
Pitch = 15.0 ± 0.4 mm			dt = 0.8 mm (+ 0.08 / - 0.05)	
0.0056 0.0062 0.0068 0.0075 0.0082 0.0091 0.010 0.011 0.012 0.013 0.015 0.016 0.018 0.020 0.022 0.024 0.027	6.0 X 12.0 X 18.0	1.4	PCMP 389F72562 PCMP 389F72622 PCMP 389F72682 PCMP 389F72752 PCMP 389F72822 PCMP 389F72912 PCMP 389F72103 PCMP 389F72113 PCMP 389F72123 PCMP 389 72133 PCMP 389 72153 PCMP 389 72163 PCMP 389 72183 PCMP 389 72203 PCMP 389 72223 PCMP 389 72243 PCMP 389 72273	PCMP 389F75562 PCMP 389F75622 PCMP 389F75682 PCMP 389F75752 PCMP 389F75822 PCMP 389F75912 PCMP 389F75103 PCMP 389F75113 PCMP 389F75123 PCMP 389 75133 PCMP 389 75153 PCMP 389 75163 PCMP 389 75183 PCMP 389 75203 PCMP 389 75223 PCMP 389 75243 PCMP 389 75273
0.030 0.033 0.036	7.0 X 13.5 X 18.0	1.9	PCMP 389 72303 PCMP 389 72333 PCMP 389 72363	PCMP 389 75303 PCMP 389 75333 PCMP 389 75363
0.039 0.043 0.047 0.051	8.5 X 15.0 X 18.0	2.6	PCMP 389 72393 PCMP 389 72433 PCMP 389 72473 PCMP 389 72513	PCMP 389 75393 PCMP 389 75433 PCMP 389 75473 PCMP 389 75513
0.056 0.062 0.068	10.0 X 16.5 X 18.0	3.1	PCMP 389 72563 PCMP 389 72623 PCMP 389 72683	PCMP 389 75563 PCMP 389 75623 PCMP 389 75683
0.075 0.082 0.091	11.0 X 18.5 X 18.0	4.1	PCMP 389 72753 PCMP 389 72823 PCMP 389 72913	PCMP 389 75753 PCMP 389 75823 PCMP 389 75913

**Metallized Polypropylene
film capacitors**

PCMP 389

$V_{Rdc} = 1000 V$

$V_{Rac} = 400 V\sim$

Cap (μF)	b x h x l (mm)	Mass (g)	CATALOGUE NUMBER	
			PCMP 389	
			loose in box	ammo packing
			lt = 5 ± 1 mm	H = 18.5 mm
			C - tol. ± 5%	C - tol. ± 5%
Pitch = 22.5 ± 0.4 mm			dt = 0.8 mm (+ 0.08 / - 0.05)	
0.039 0.043 0.047 0.051 0.056 0.062 0.068	7.0 X 16.5 X 26.0	3.2	PCMP 389J72393 PCMP 389J72433 PCMP 389J72473 PCMP 389J72513 PCMP 389J72563 PCMP 389J72623 PCMP 389J72683	PCMP 389J75393 PCMP 389J75433 PCMP 389J75473 PCMP 389J75513 PCMP 389J75563 PCMP 389J75623 PCMP 389J75683
0.075 0.082 0.091 0.10	8.5 X 18.0 X 26.0	4.4	PCMP 389J72753 PCMP 389J72823 PCMP 389J72913 PCMP 389 72104	PCMP 389J75753 PCMP 389J75823 PCMP 389J75913 PCMP 389 75104
0.11 0.12 0.13 0.15	10.0 X 19.5 X 26.0	5.5	PCMP 389 72114 PCMP 389 72124 PCMP 389 72134 PCMP 389 72154	PCMP 389 75114 PCMP 389 75124 PCMP 389 75134 PCMP 389 75154
0.16 0.18	11.5 X 21.0 X 26.0	6.7	PCMP 389 72164 PCMP 389 72184	PCMP 389 75164 PCMP 389 75184
0.20 0.22	12.0 X 22.0 X 26.0	7.0	PCMP 389 72204 PCMP 389 72224	PCMP 389 75204 PCMP 389 75224
Pitch = 27.5 ± 0.4 mm			dt = 0.8 mm (+ 0.08 / - 0.05)	
0.039 0.043 0.047 0.051 0.056 0.062 0.068 0.075 0.082 0.091 0.10 0.11 0.12 0.13 0.15 0.16 0.18 0.20	11.0 X 21.0 X 31.0	8.2	PCMP 389L72393 PCMP 389L72433 PCMP 389L72473 PCMP 389L72513 PCMP 389L72563 PCMP 389L72623 PCMP 389L72683 PCMP 389L72753 PCMP 389L72823 PCMP 389L72913 PCMP 389L72104 PCMP 389L72114 PCMP 389L72124 PCMP 389L72134 PCMP 389L72154 PCMP 389L72164 PCMP 389L72184 PCMP 389L72204	- - - - - - - - - - - - - - - - - -
0.22 0.24 0.27 0.30	13.0 X 23.0 X 31.0	10.4	PCMP 389L72224 PCMP 389 72244 PCMP 389 72274 PCMP 389 72304	- - - -
0.33 0.36 0.39	15.0 X 25.0 X 31.0	12.8	PCMP 389 72334 PCMP 389 72364 PCMP 389 72394	- - -
0.43 0.47 0.51 0.56	18.0 X 28.0 X 31.0	17.2	PCMP 389 72434 PCMP 389 72474 PCMP 389 72514 PCMP 389 72564	- - - -

Metallized Polypropylene film capacitors

PCMP 389

 $V_{Rdc} = 1250 V$
 $V_{Rac} = 500 V$

Cap (μF)	b x h x l (mm)	Mass (g)	CATALOGUE NUMBER	
			PCMP 389	
			loose in box	ammo packing
			lt = 5 \pm 1 mm	H = 18.5 mm
			C - tol. \pm 5%	C - tol. \pm 5%
Pitch = 10.0 \pm 0.4 mm		dt = 0.6 mm (+ 0.06 / - 0.05)		
0.0020 0.0022 0.0024 0.0027 0.0030 0.0033 0.0036 0.0039 0.0043 0.0047 0.0051 0.0056 0.0062	5.0 x 11.0 x 12.5	0.9	PCMP 389 N2202 PCMP 389 N2222 PCMP 389 N2242 PCMP 389 N2272 PCMP 389 N2302 PCMP 389 N2332 PCMP 389 N2362 PCMP 389 N2392 PCMP 389 N2432 PCMP 389 N2472 PCMP 389 N2512 PCMP 389 N2562 PCMP 389 N2622	PCMP 389 N5202 PCMP 389 N5222 PCMP 389 N5242 PCMP 389 N5272 PCMP 389 N5302 PCMP 389 N5332 PCMP 389 N5362 PCMP 389 N5392 PCMP 389 N5432 PCMP 389 N5472 PCMP 389 N5512 PCMP 389 N5562 PCMP 389 N5622
0.0068 0.0075 0.0082 0.0091	6.0 x 12.0 x 12.5	1.0	PCMP 389 N2682 PCMP 389 N2752 PCMP 389 N2822 PCMP 389 N2912	PCMP 389 N5682 PCMP 389 N5752 PCMP 389 N5822 PCMP 389 N5912
Pitch = 15.0 \pm 0.4 mm		dt = 0.8 mm (+ 0.08 / - 0.05)		
0.0056 0.0062 0.0068 0.0075 0.0082 0.0091 0.010 0.011 0.012 0.013 0.015 0.016 0.018 0.020	6.0 X 12.0 X 18.0	1.4	PCMP 389FN2562 PCMP 389FN2622 PCMP 389FN2682 PCMP 389FN2752 PCMP 389FN2822 PCMP 389FN2912 PCMP 389 N2103 PCMP 389 N2113 PCMP 389 N2123 PCMP 389 N2133 PCMP 389 N2153 PCMP 389 N2163 PCMP 389 N2183 PCMP 389 N2203	PCMP 389FN5562 PCMP 389FN5622 PCMP 389FN5682 PCMP 389FN5752 PCMP 389FN5822 PCMP 389FN5912 PCMP 389 N5103 PCMP 389 N5113 PCMP 389 N5123 PCMP 389 N5133 PCMP 389 N5153 PCMP 389 N5163 PCMP 389 N5183 PCMP 389 N5203
0.022 0.024 0.027	7.0 X 13.5 X 18.0	1.9	PCMP 389 N2223 PCMP 389 N2243 PCMP 389 N2273	PCMP 389 N5223 PCMP 389 N5243 PCMP 389 N5273
0.030 0.033 0.036 0.039	8.5 X 15.0 X 18.0	2.6	PCMP 389 N2303 PCMP 389 N2333 PCMP 389 N2363 PCMP 389 N2393	PCMP 389 N5303 PCMP 389 N5333 PCMP 389 N5363 PCMP 389 N5393
0.043 0.047 0.051	10.0 X 16.5 X 18.0	3.1	PCMP 389 N2433 PCMP 389 N2473 PCMP 389 N2513	PCMP 389 N5433 PCMP 389 N5473 PCMP 389 N5513
0.056 0.062 0.068	11.0 X 18.5 X 18.0	4.1	PCMP 389 N2563 PCMP 389 N2623 PCMP 389 N2683	PCMP 389 N5563 PCMP 389 N5623 PCMP 389 N5683

Metallized Polypropylene film capacitors

PCMP 389

 $V_{Rdc} = 1250 V$
 $V_{Rac} = 500 V$

Cap (μF)	b x h x l (mm)	Mass (g)	CATALOGUE NUMBER	
			PCMP 389	
			loose in box	ammo packing
			lt = 5 \pm 1 mm	H = 18.5 mm
			C - tol. \pm 5%	C - tol. \pm 5%
Pitch = 22.5 \pm 0.4 mm dt = 0.8 mm (+ 0.08 / - 0.05)				
0.039 0.043 0.047 0.051	7.0 X 16.5 X 26.0	3.2	PCMP 389JN2393 PCMP 389JN2433 PCMP 389JN2473 PCMP 389JN2513	PCMP 389JN5393 PCMP 389JN5433 PCMP 389JN5473 PCMP 389JN5513
0.056 0.062 0.068 0.075	8.5 X 18.0 X 26.0	4.4	PCMP 389JN2563 PCMP 389JN2623 PCMP 389JN2683 PCMP 389 N2753	PCMP 389JN5563 PCMP 389JN5623 PCMP 389JN5683 PCMP 389 N5753
0.082 0.091 0.10 0.11	10.0 X 19.5 X 26.0	5.5	PCMP 389 N2823 PCMP 389 N2913 PCMP 389 N2104 PCMP 389 N2114	PCMP 389 N5823 PCMP 389 N5913 PCMP 389 N5104 PCMP 389 N5114
0.12 0.13	11.5 X 21.0 X 26.0	6.7	PCMP 389 N2124 PCMP 389 N2134	PCMP 389 N5124 PCMP 389 N5134
0.15 0.16	12.0 X 22.0 X 26.0	7.0	PCMP 389 N2154 PCMP 389 N2164	PCMP 389 N5154 PCMP 389 N5164
Pitch = 27.5 \pm 0.4 mm dt = 0.8 mm (+ 0.08 / - 0.05)				
0.039 0.043 0.047 0.051 0.056 0.062 0.068 0.075 0.082 0.091 0.10 0.11 0.12 0.13 0.15 0.16	11.0 X 21.0 X 31.0	7.8	PCMP 389LN2393 PCMP 389LN2433 PCMP 389LN2473 PCMP 389LN2513 PCMP 389LN2563 PCMP 389LN2623 PCMP 389LN2683 PCMP 389LN2753 PCMP 389LN2823 PCMP 389LN2913 PCMP 389LN2104 PCMP 389LN2114 PCMP 389LN2124 PCMP 389LN2134 PCMP 389LN2154 PCMP 389LN2164	- - - - - - - - - - - - - - - -
0.18 0.20 0.22	13.0 X 23.0 X 31.0	10.4	PCMP 389 N2184 PCMP 389 N2204 PCMP 389 N2224	- - -
0.24 0.27 0.30	15.0 X 25.0 X 31.0	12.8	PCMP 389 N2244 PCMP 389 N2274 PCMP 389 N2304	- - -
0.33 0.36 0.39	18.0 X 28.0 X 31.0	17.2	PCMP 389 N2334 PCMP 389 N2364 PCMP 389 N2394	- - -

Metallized Polypropylene film capacitors

PCMP 389

 $V_{Rdc} = 1600\text{ V}$
 $V_{Rac} = 600\text{ V}$

Cap (μF)	b x h x l (mm)	Mass (g)	CATALOGUE NUMBER	
			PCMP 389	
			loose in box	ammo packing
			lt = $5 \pm 1\text{ mm}$	H = 18.5 mm
C - tol. $\pm 5\%$		C - tol. $\pm 5\%$		
Pitch = $15.0 \pm 0.4\text{ mm}$ dt = 0.6 mm (+ 0.06 / - 0.05)				
0.0047 0.0051 0.0056 0.0062 0.0068	5.0 X 11.0 X 18.0	1.2	PCMP 389F82472 PCMP 389F82512 PCMP 389F82562 PCMP 389F82622 PCMP 389F82682	PCMP 389F85472 PCMP 389F85512 PCMP 389F85562 PCMP 389F85622 PCMP 389F85682
0.0075 0.0082 0.0091 0.010	6.0 X 12.0 X 18.0	1.4	PCMP 389F82752 PCMP 389F82822 PCMP 389F82912 PCMP 389F82103	PCMP 389F85752 PCMP 389F85822 PCMP 389F85912 PCMP 389F85103
Pitch = $15.0 \pm 0.4\text{ mm}$ dt = 0.8 mm (+ 0.08 / - 0.05)				
0.011 0.012 0.013	7.0 X 13.5 X 18.0	1.9	PCMP 389F82113 PCMP 389F82123 PCMP 389F82133	PCMP 389F85113 PCMP 389F85123 PCMP 389F85133
0.015 0.016 0.018	8.5 X 15.0 X 18.0	2.6	PCMP 389F82153 PCMP 389F82163 PCMP 389F82183	PCMP 389F85153 PCMP 389F85163 PCMP 389F85183
0.020 0.022 0.024	10.0 X 16.5 X 18.0	3.1	PCMP 389F82203 PCMP 389F82223 PCMP 389F82243	PCMP 389F85203 PCMP 389F85223 PCMP 389F85243
0.027 0.030 0.033 0.036 0.039	11.0 X 18.5 X 18.0	4.1	PCMP 389F82273 PCMP 389F82303 PCMP 389F82333 PCMP 389F82363 PCMP 389F82393	PCMP 389F85273 PCMP 389F85303 PCMP 389F85333 PCMP 389F85363 PCMP 389F85393

Metallized Polypropylene film capacitors

PCMP 389

 $V_{Rdc} = 2000\text{ V}$
 $V_{Rac} = 700\text{ V}$

Cap (μF)	b x h x l (mm)	Mass (g)	CATALOGUE NUMBER		
			PCMP 389		
			loose in box	ammo packing	
			lt = $5 \pm 1\text{ mm}$	H = 18.5 mm	
		C - tol. $\pm 5\%$		C - tol. $\pm 5\%$	
Pitch = $15.0 \pm 0.4\text{ mm}$ dt = 0.6 mm (+ 0.06 / - 0.05)					
0.00082 0.00091 0.0010 0.0011 0.0012 0.0013 0.0015 0.0018 0.0020 0.0022 0.0024 0.0027 0.0030 0.0033 0.0036 0.0039 0.0043	5.0 X 11.0 X 18.0	1.2	PCMP 389F92821 PCMP 389F92911 PCMP 389F92102 PCMP 389F92112 PCMP 389F92122 PCMP 389F92132 PCMP 389F92152 PCMP 389F92182 PCMP 389F92202 PCMP 389F92222 PCMP 389F92242 PCMP 389F92272 PCMP 389F92302 PCMP 389F92332 PCMP 389F92362 PCMP 389F92392 PCMP 389F92432	PCMP 389F95821 PCMP 389F95911 PCMP 389F95102 PCMP 389F95112 PCMP 389F95122 PCMP 389F95132 PCMP 389F95152 PCMP 389F95182 PCMP 389F95202 PCMP 389F95222 PCMP 389F95242 PCMP 389F95272 PCMP 389F95303 PCMP 389F95332 PCMP 389F95362 PCMP 389F95392 PCMP 389F95432	
0.0047 0.0051 0.0056 0.0062 0.0068	6.0 X 12.0 X 18.0	1.4	PCMP 389F92472 PCMP 389F92512 PCMP 389F92562 PCMP 389F92622 PCMP 389F92682	PCMP 389F95472 PCMP 389F95512 PCMP 389F95562 PCMP 389F95622 PCMP 389F95682	
Pitch = $15.0 \pm 0.4\text{ mm}$ dt = 0.8 mm (+ 0.08 / - 0.05)					
0.0075 0.0082 0.0091 0.010	7.0 X 13.5 X 18.0	1.9	PCMP 389F92752 PCMP 389F92822 PCMP 389F92912 PCMP 389F92103	PCMP 389F95752 PCMP 389F95822 PCMP 389F95912 PCMP 389F95103	
0.011 0.012 0.013	8.5 X 15.0 X 18.0	2.6	PCMP 389F92113 PCMP 389F92123 PCMP 389F92133	PCMP 389F95113 PCMP 389F95123 PCMP 389F95133	
0.015 0.016	10.0 X 16.5 X 18.0	3.1	PCMP 389F92153 PCMP 389F92163	PCMP 389F95153 PCMP 389F95163	
0.018 0.020 0.022 0.024	11.0 X 18.5 X 18.0	4.1	PCMP 389F92183 PCMP 389F92203 PCMP 389F92223 PCMP 389F92243	PCMP 389F95183 PCMP 389F95203 PCMP 389F95223 PCMP 389F95243	

MOUNTING

NORMAL USE

The capacitors are designed for mounting on printed-circuit boards. The capacitors packed in bandoilers are designed for mounting on printed-circuit boards by means of automatic insertion machines.

SPECIFIC METHOD OF MOUNTING TO WITHSTAND VIBRATION AND SHOCK

- . For pitches of 15 mm the capacitors shall be mechanically fixed by the leads.
- . For larger pitches the capacitors shall be mounted in the same way and the body clamped.

SPACE REQUIREMENTS ON PRINTED-CIRCUIT BOARD

The maximum length and width of film capacitors are shown in the following drawing ;

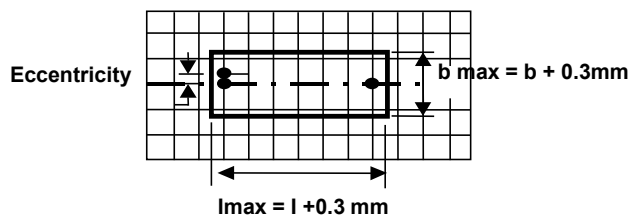

- Eccentricity as in drawing.

The maximum eccentricity is smaller than or equal to the lead diameter of the product concerned.

- Product height with seating plane as given by IEC 60717 as reference : $h_{max} \leq h + 0.3 \text{ mm}$

STORAGE TEMPERATURE

.Storage temperature : $T_{stg} = -25$ to $+40$ °C with RH maximum 80% without condensation.

RATINGS AND CHARACTERISTICS

Unless otherwise specified all electrical values apply at an ambient temperature of 23 ± 1 °C, an atmospheric pressure of 86 to 106 kPa and a relative humidity of 50 ± 2 %.

For reference testing a conditioning period shall be applied of 96 ± 4 hours by heating the products in a circulating air oven at the rated temperature and a relative humidity not exceeding 20%.

CHARACTERISTICS

● Test Voltage

- . Test Voltage (between leads) : $1.6 \times V_{Rdc}$, 1min (cut-off current 10mA)
- . Test Voltage (between leads and case) : $2840 V_{dc}$, 1min

● Dissipation Factor

Rated voltage	Capacitance	Tangent of loss angle ($\times 10^{-4}$)		
		1 kHz	10 kHz	100 kHz
250 V	$0.047 \mu F \leq C \leq 0.12 \mu F$	≤ 5	≤ 5	≤ 30
	$0.12 \mu F < C \leq 0.33 \mu F$	≤ 5	≤ 8	≤ 40
	$0.33 \mu F < C \leq 0.56 \mu F$	≤ 5	≤ 10	≤ 50
	$0.56 \mu F < C \leq 0.91 \mu F$	≤ 5	≤ 10	≤ 60
	$0.91 \mu F < C \leq 1.5 \mu F$	≤ 6	≤ 10	≤ 80
	$1.5 \mu F < C \leq 2.2 \mu F$	≤ 6	≤ 10	≤ 100
	$2.2 \mu F < C \leq 3.9 \mu F$	≤ 6	≤ 15	≤ 135
400 V	$0.022 \mu F \leq C \leq 0.075 \mu F$	≤ 5	≤ 5	≤ 20
	$0.075 \mu F < C \leq 0.39 \mu F$	≤ 5	≤ 8	≤ 40
	$0.39 \mu F < C \leq 0.91 \mu F$	≤ 5	≤ 10	≤ 60
	$0.91 \mu F < C \leq 1.5 \mu F$	≤ 6	≤ 10	≤ 80
	$1.5 \mu F < C \leq 2.0 \mu F$	≤ 6	≤ 10	≤ 95
630 V	$0.010 \mu F \leq C \leq 0.068 \mu F$	≤ 5	≤ 5	≤ 15
	$0.068 \mu F < C \leq 0.39 \mu F$	≤ 5	≤ 8	≤ 40
	$0.39 \mu F < C \leq 1.0 \mu F$	≤ 5	≤ 10	≤ 60
1000V	$C \leq 0.012 \mu F$	≤ 5	≤ 7	≤ 15
	$0.013 \mu F \leq C \leq 0.091 \mu F$	≤ 5	≤ 7	≤ 25
	$0.10 \mu F \leq C \leq 0.56 \mu F$	≤ 5	≤ 7	≤ 35
1250V	$C \leq 0.0091 \mu F$	≤ 5	≤ 7	≤ 15
	$0.010 \mu F \leq C \leq 0.091 \mu F$	≤ 5	≤ 7	≤ 25
	$0.10 \mu F \leq C \leq 0.39 \mu F$	≤ 5	≤ 7	≤ 35
1600V	$0.0047 \mu F \leq C \leq 0.039 \mu F$	≤ 5	≤ 7	≤ 25
2000V	$0.00082 \mu F \leq C \leq 0.024 \mu F$	≤ 5	≤ 7	≤ 20

● Insulation Resistance

The insulation resistance is measured for 1min \pm 5s, at 100V for $V_{Rdc} < 630V$, at 500V for $V_{Rdc} \geq 630V$
Between terminals :

$$C \leq 0.33\mu F : R > 100\,000\,M\Omega$$

$$C > 0.33\mu F : RC \geq 30\,000\,s$$

● Rated Voltage Pulse Lode Slope (dV/dt)_R

For values see specific reference data. If the pulse voltage is lower than the rated voltage, the values of the specific reference data must be multiplied by V_{Rdc} and divided by the applied voltage

Rated voltage	MAXIMUM RATED VOLTAGE PULSE SLOPE (V/ μ S)			
	P = 10.0 mm	P = 15.0 mm	P = 22.5 mm	P = 27.5 mm
250 V	280	200	125	50
400 V	420	300	180	70
630 V	550	400	250	100
1000 V	2000	1300	800	380
1250 V	4000	1850	1150	600
1600 V	-	6000	-	-
2000 V	-	9500	-	-

THE GRAPHS OF CHARACTERISTICS

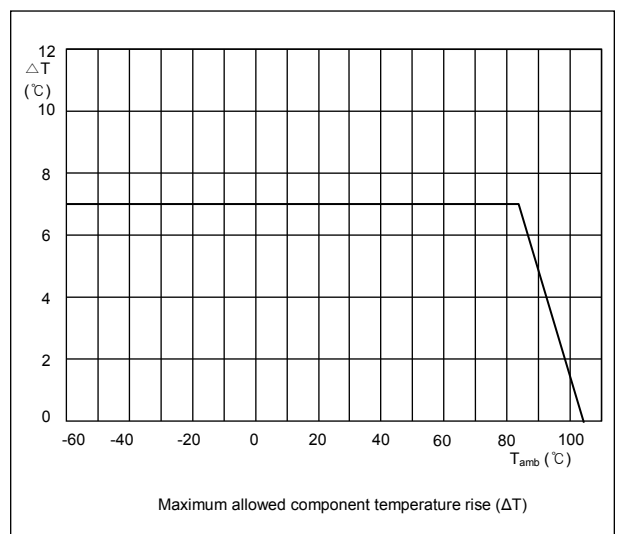
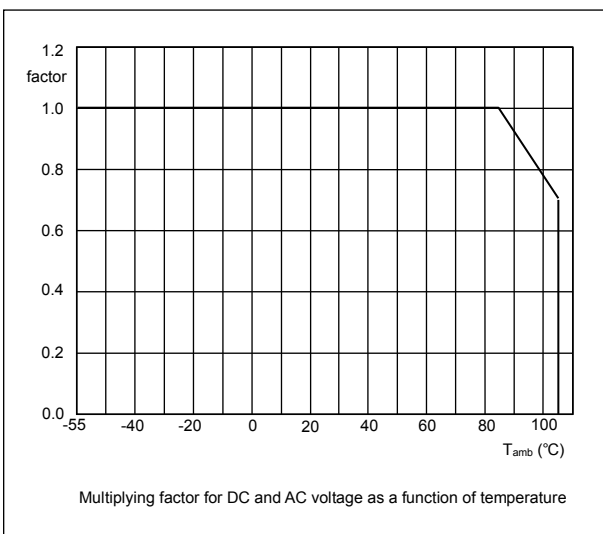
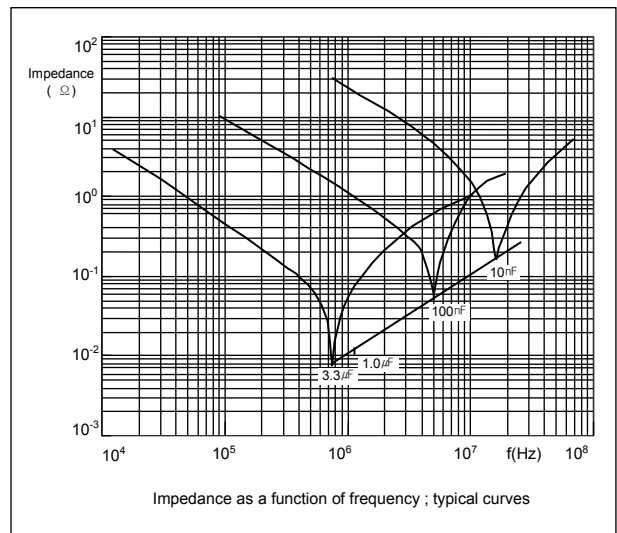
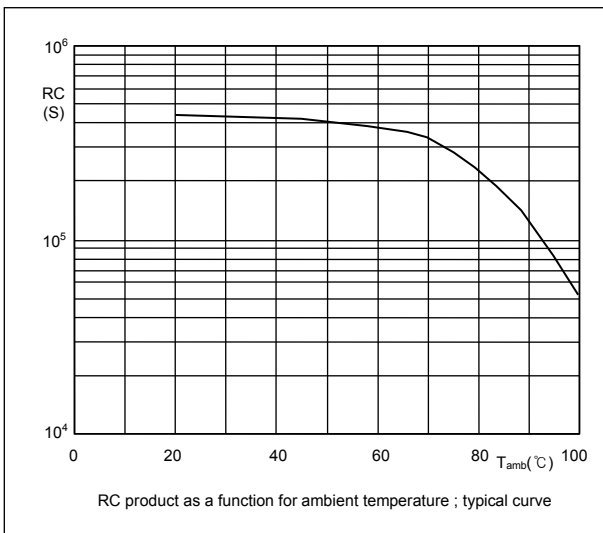
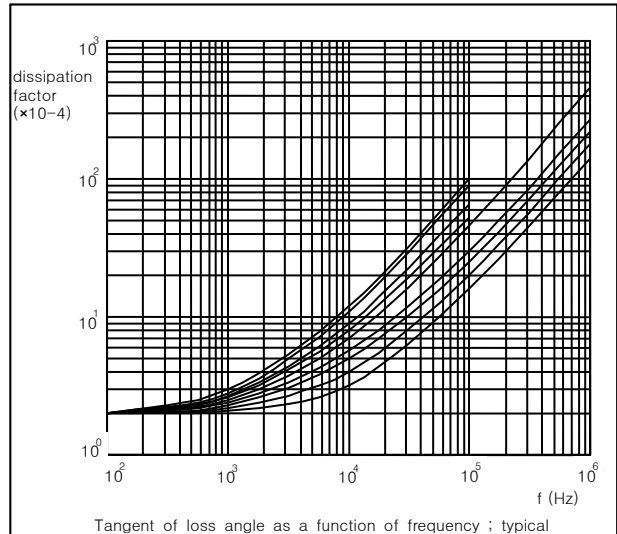
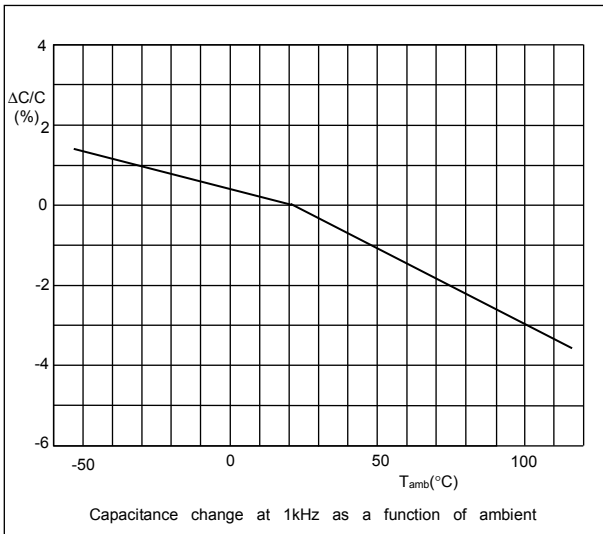

Metallized Polypropylene film capacitors

PCMP 389

MAXIMUM RMS VOLTAGE (SINEWAVE) AS A FUNCTION OF FREQUENCY (250V~630V)

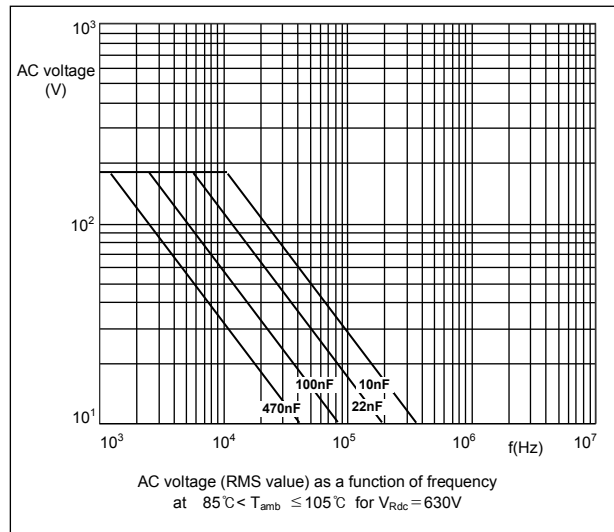
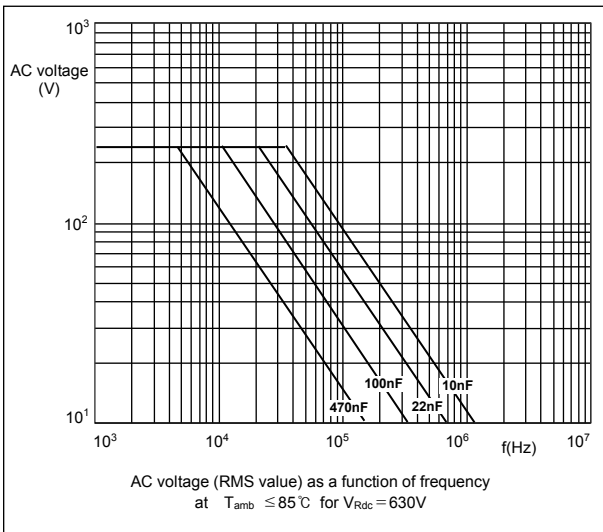
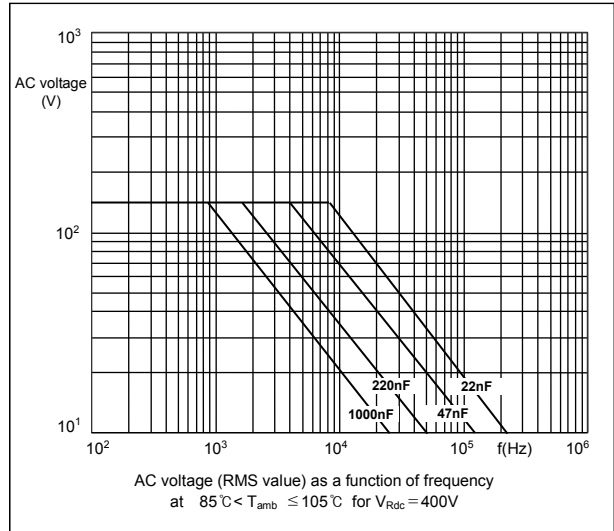
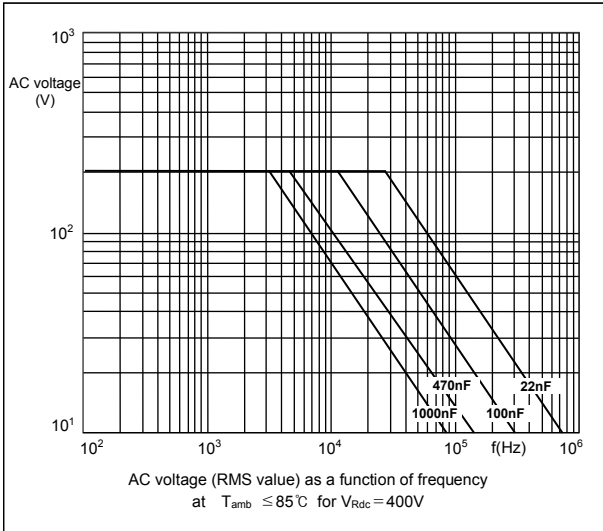
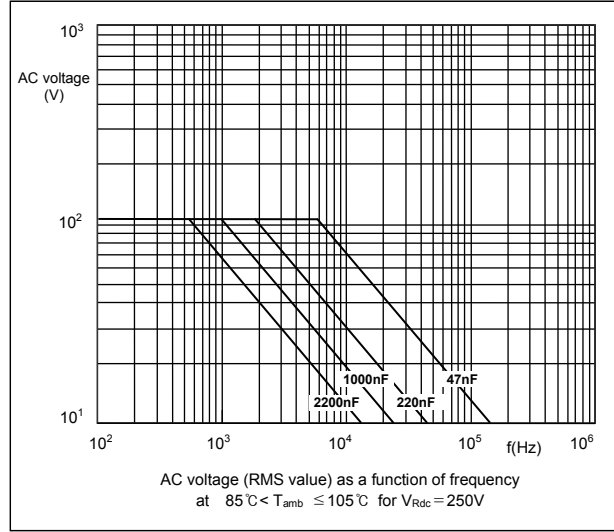
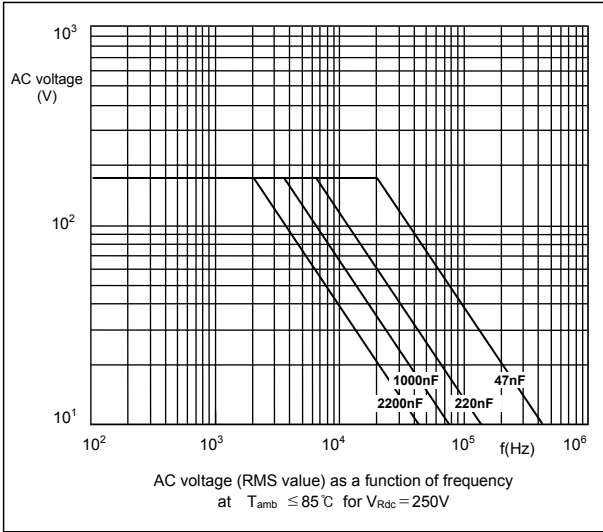

MAXIMUM RMS VOLTAGE (SINEWAVE) AS A FUNCTION OF FREQUENCY (1000V~2000V)

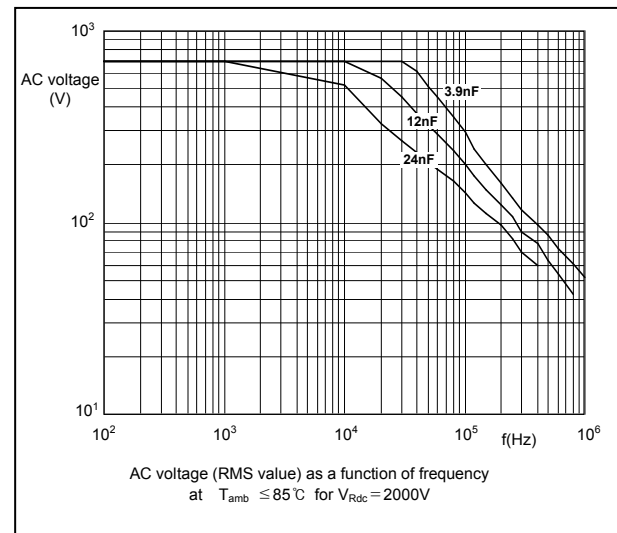
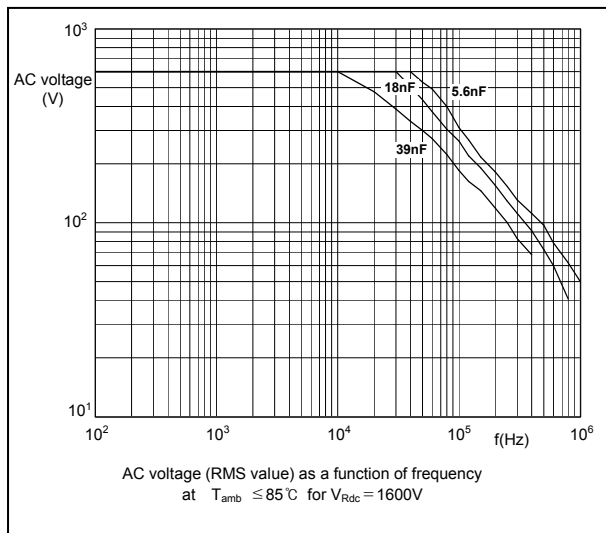
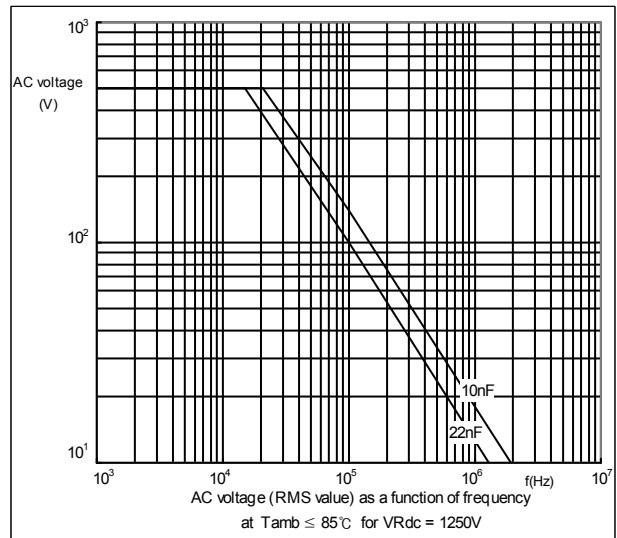
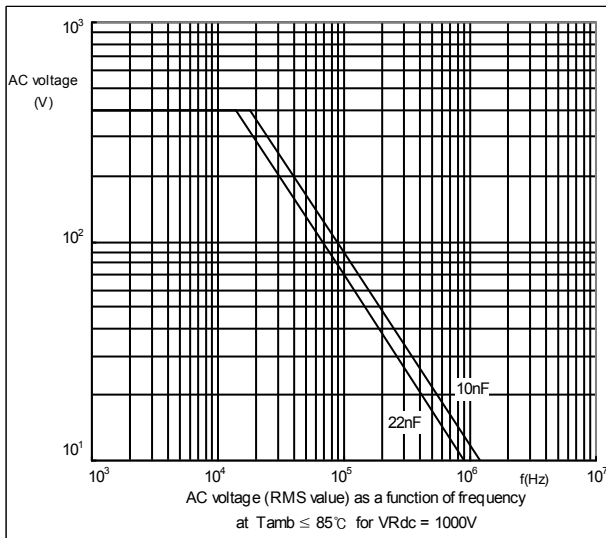

APPLICATION NOTE AND LIMITING CONDITIONS

These capacitors are not suitable for mains application as across-the-line capacitors without additional protection.

To select the capacitor for a certain application, the following conditions must be checked :

1. The peak voltage (V_p) shall not be greater than the rated DC voltage (V_{Rdc}).
2. The peak-to-peak voltage (V_{p-p}) shall not be greater than the maximum V_{p-p} to avoid the ionisation inception level.
3. The voltage pulse slope (dV/dt) shall not exceed the rated voltage pulse slope in an RC-circuit at rated voltage and without ringing. If the pulse voltage is lower than the rated DC voltage, the rated voltage pulse slope may be multiplied by V_{Rdc} and divided by the applied voltage.

For all other pulses following equation must be fulfilled :

$$2 \times \int_0^T \left(\frac{dU}{dt} \right)^2 dt < U_{Rdc} \times \left(\frac{dU}{dt} \right)_{rated}$$

T is the pulse duration.

4. The maximum component surface temperature rise must be lower than the limits.
5. To ensure withstanding high humidity requirements in the application it is recommended not to damage the epoxy adhesion at the leads. Therefore the leads may not be damaged or bent before soldering.

PRODUCT MARKING

Capacitors are marked with the following information :

- . Rated capacitance code in accordance with IEC 60062
- . Tolerance on rated capacitance : J = \pm 5 %
- . Rated (DC) Voltage (e.g. 630 V)
- . Code for dielectric material (MKP)
- . Manufacturer's type designation (389)
- . Manufacturer's name (PILKOR)
- . Year and week of manufacture (e.g. 1401)
- . White or black color

Example of marking

10n J 630V 389 MKP 1401 PILKOR

Marking on the side

36n J 630V 389 MKP

Marking on the top

PILKOR WK....

Marking on the side

120n J 630V 389 MKP

Marking on the top

PILKOR WK....

Marking on the side

or

120n J 630V 389 MKP	PILKOR WK....
------------------------	------------------

Marking on the top

470n J 630V 389 MKP 1401 PILKOR

Marking on the top