

SMD ▪ Middle Power LED 50-217ST/KK5C-HXXXXXXZ15/2T



Features

- PLCC-2 package
- Top view white LED
- High luminous intensity output
- Wide viewing angle
- Pb-free
- ANSI Binning
- The product itself will remain within RoHS compliant version.
- Compliance with EU REACH.
- Compliance Halogen Free .(Br<900ppm,Cl<900ppm,Br+Cl<1500ppm)

Description

The Everlight 50-217ST package has high efficacy, high CRI, Middle power consumption, wide viewing angle and a compact form factor. These features make this package an ideal LED for all lighting applications.

Applications

- General lighting
- Decorative and Entertainment Lighting
- Indicators
- Illumination
- Switch lights

Product Number Explanation

50-217S T/K K5C – H XX XX 34 Z 15 / 2 T

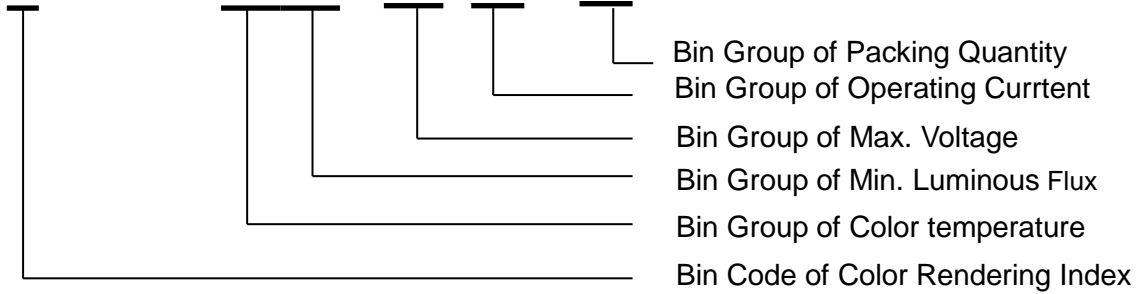

Table of Color Rendering Index

Symbol	Description
M	CRI(Min.) : 60
N	CRI(Min.) : 65
L	CRI(Min.) : 70
Q	CRI(Min.) : 75
K	CRI(Min.) : 80
H	CRI(Min.) : 90

Note:
 Tolerance of Color Rendering Index: ±2

Table of Forward Current Index

Symbol	Description
15	I _F :150mA

Table of Forward Voltage Index

Symbol	Description
34	3.4V max

Example:
 50-217ST/KK5C-H275534Z15/2T

CRI	80(Min.)
CCT	2700K
Flux	55lm min
V _F	3.4V max
I _F	150mA

Mass Production List

Product	CRI Min. ⁽¹⁾	CCT(K)	Φ(lm) Min. ⁽²⁾
50-217ST/KK5C-H275534Z15/2T	80	2700K	55
50-217ST/KK5C-H306034Z15/2T	80	3000K	60
50-217ST/KK5C-H406534Z15/2T	80	4000K	65
50-217ST/KK5C-H506534Z15/2T	80	5000K	65
50-217ST/KK5C-H576534Z15/2T	80	5700K	65
50-217ST/KK5C-H656534Z15/2T	80	6500K	65

Note:

1. Tolerance of Color Rendering Index: ± 2
2. Tolerance of Luminous flux: $\pm 11\%$.

Device Selection Guide

Chip Materials	Emitted Color	Resin Color
InGaN	Cool White Natural White Warm White	Water Clear

Absolute Maximum Ratings (T_{Soldering}=25°C)

Parameter	Symbol	Rating	Unit
Forward Current	I _F	150	mA
Peak Forward Current (Duty 1/10 @10ms)	I _{FP}	300	mA
Power Dissipation	P _d	510	mW
Operating Temperature	T _{opr}	-40 ~ +85	°C
Storage Temperature	T _{stg}	-40 ~ +100	°C
Thermal Resistance (Junction / Soldering point)	R _{th J-S}	32	°C/W
Junction Temperature	T _j	115	°C
Soldering Temperature	T _{sol}	Reflow Soldering : 260 °C for 10 sec. Hand Soldering : 350 °C for 3 sec.	

Note:

The products are sensitive to static electricity and must be carefully taken when handling products

Electro-Optical Characteristics (T_{Soldering}=25°C)

Parameter	Symbol	Min.	Typ.	Max.	Unit	Condition
Luminous Flux ₍₁₎	Φ	55	-----	-----	lm	I _F =150mA
Forward Voltage ₍₂₎	V _F	2.8	-----	3.4	V	I _F =150mA
Color Rendering Index ₍₃₎	Ra	80	-----	-----		I _F =150mA
Viewing Angle	2θ _{1/2}	-----	120	-----	deg	I _F =150mA
Reverse Current	I _R	-----	-----	50	μA	V _R =5V

Notes:

1. Tolerance of Luminous flux: ±11%.
2. Tolerance of Forward Voltage : ±0.1V.
3. Tolerance of Color Rendering Index: ±2

Bin Range of Luminous Flux

Bin Code	Min.	Max.	Unit	Condition
R2	55	60	lm	I _F =150mA
R3	60	65		
R4	65	70		
R5	70	76		
R6	76	83		

Note:
Tolerance of Luminous flux: ±11%.

Bin Range of Forward Voltage

Bin Code	Min.	Max.	Unit	Condition
35	2.8	2.9	V	I _F =150mA
36	2.9	3.0		
37	3.0	3.1		
38	3.1	3.2		
39	3.2	3.3		
40	3.3	3.4		

Note:
Tolerance of Forward Voltage: ±0.1V.

The C.I.E. 1931 Chromaticity Diagram

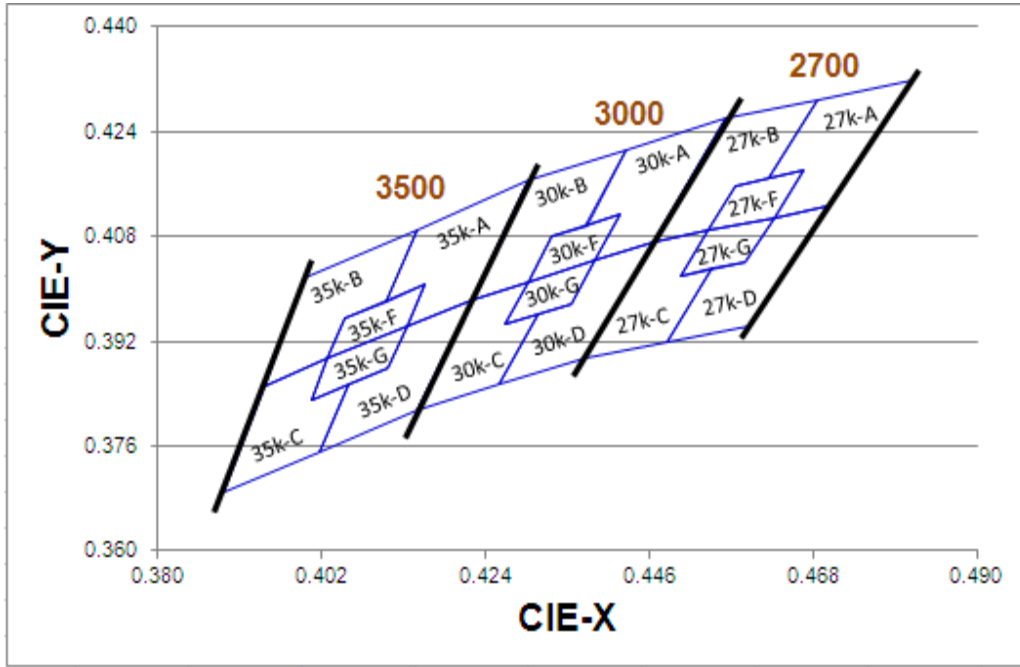

Bin Range of Chromaticity Coordinates

CCT	Bin Code	CIE_x	CIE_y	Bin Code	CIE_x	CIE_y	
2700K	27K-A	0.4813	0.4319	27K-D	0.4700	0.4126	
		0.4687	0.4289		0.4627	0.4109	
		0.4621	0.4169		0.4588	0.4041	
		0.4667	0.4180		0.4544	0.4030	
		0.4627	0.4109		0.4483	0.3919	
		0.4700	0.4126		0.4593	0.3944	
	Reference Range:2580K~2700K						
	27K-B	0.4687	0.4289	27K-C	0.4465	0.4071	
		0.4562	0.4260		0.4373	0.3893	
		0.4465	0.4071		0.4483	0.3919	
		0.4539	0.4088		0.4544	0.4030	
		0.4576	0.4158		0.4502	0.4020	
0.4621		0.4169	0.4539		0.4088		
Reference Range:2700K~2870K							
27K-F	0.4667	0.4180	27K-G	0.4627	0.4109		
	0.4576	0.4158		0.4539	0.4088		
	0.4539	0.4088		0.4502	0.4020		
	0.4627	0.4109		0.4588	0.4041		
Reference Range: 2665K~2770K							

CCT	Bin Code	CIE_x	CIE_y	Bin Code	CIE_x	CIE_y	
3000K	30K-A	0.4562	0.4260	30K-D	0.4465	0.4071	
		0.4430	0.4212		0.4388	0.4043	
		0.4375	0.4096		0.4355	0.3977	
		0.4422	0.4113		0.4311	0.3962	
		0.4388	0.4043		0.4259	0.3853	
		0.4465	0.4071		0.4373	0.3893	
	Reference Range:2870K~3000K						
	30K-B	0.4430	0.4212	30K-C	0.4221	0.3984	
		0.4299	0.4165		0.4147	0.3814	
		0.4221	0.3984		0.4259	0.3853	
		0.4297	0.4011		0.4311	0.3962	
		0.4328	0.4079		0.4267	0.3946	
		0.4375	0.4096		0.4297	0.4011	
	Reference Range:3000K~3220K						
	30K-F	0.4422	0.4113	30K-G	0.4388	0.4043	
		0.4328	0.4079		0.4297	0.4011	
		0.4297	0.4011		0.4267	0.3946	
		0.4388	0.4043		0.4355	0.3977	
	Reference Range:2960K~3080K						

The C.I.E. 1931 Chromaticity Diagram

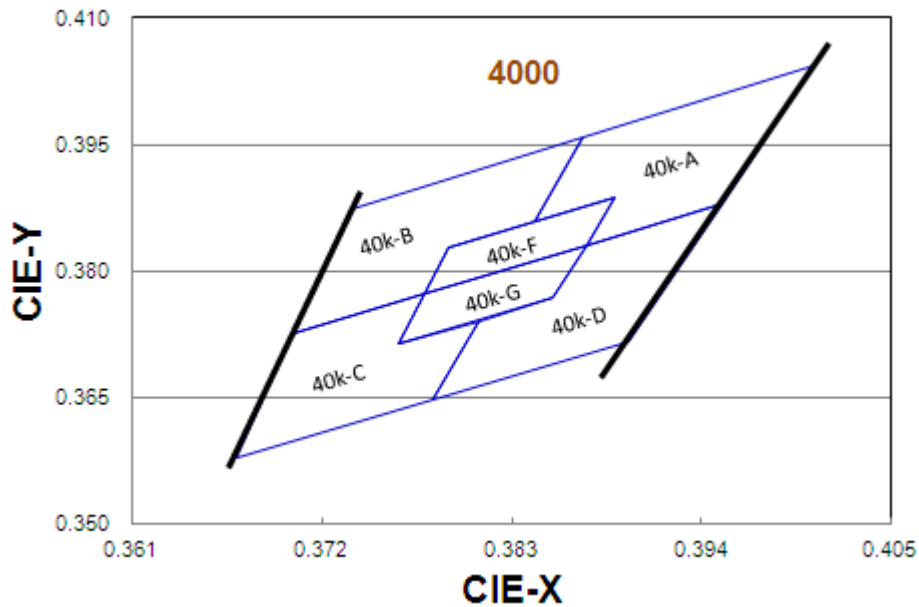

Bin Range of Chromaticity Coordinates

CCT	Bin Code	CIE_x	CIE_y	Bin Code	CIE_x	CIE_y	
4000K	40K-A	0.4006	0.4044	40K-D	0.3952	0.3880	
		0.3871	0.3959		0.3873	0.3831	
		0.3843	0.3858		0.3854	0.3768	
		0.3890	0.3887		0.3810	0.3741	
		0.3873	0.3831		0.3784	0.3647	
		0.3952	0.3880		0.3898	0.3716	
	Reference Range:3700K~3970K						
	40K-B	0.3871	0.3959	40K-C	0.3703	0.3726	
		0.3736	0.3874		0.3670	0.3578	
		0.3703	0.3726		0.3784	0.3647	
		0.3779	0.3773		0.3810	0.3741	
		0.3793	0.3828		0.3764	0.3713	
		0.3843	0.3858		0.3779	0.3773	
	Reference Range:3970K~4270K						
	40K-F	0.3890	0.3887	40K-G	0.3873	0.3831	
		0.3793	0.3828		0.3779	0.3773	
		0.3779	0.3773		0.3764	0.3713	
		0.3873	0.3831		0.3854	0.3768	
	Reference Range:3870K~4080K						

The C.I.E. 1931 Chromaticity Diagram

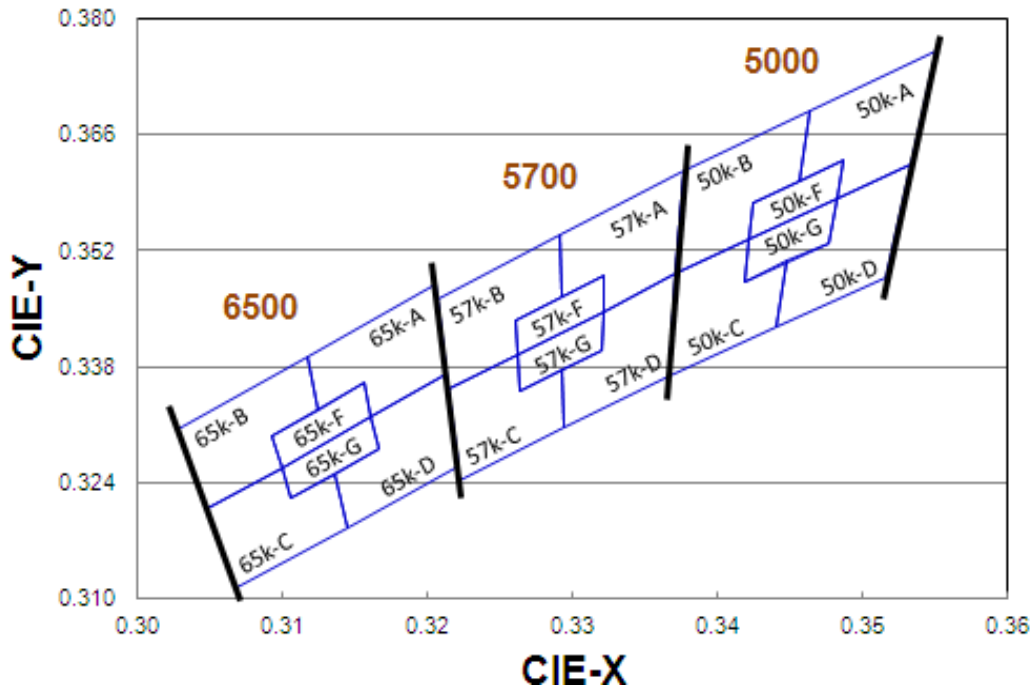

Bin Range of Chromaticity Coordinates

CCT	Bin Code	CIE_x	CIE_y	Bin Code	CIE_x	CIE_y	
5000K	50K-A	0.3551	0.3760	50K-D	0.3533	0.3624	
		0.3464	0.3688		0.3482	0.3583	
		0.3456	0.3604		0.3477	0.3530	
		0.3487	0.3629		0.3448	0.3507	
		0.3482	0.3583		0.3441	0.3428	
		0.3533	0.3624		0.3515	0.3487	
	Reference Range:4745K~5000K						
	50K-B	0.3464	0.3688	50K-C	0.3371	0.3493	
		0.3376	0.3616		0.3366	0.3369	
		0.3371	0.3493		0.3441	0.3428	
		0.3422	0.3533		0.3448	0.3507	
		0.3425	0.3579		0.3418	0.3483	
		0.3456	0.3604		0.3422	0.3533	
	Reference Range:5000K~5310K						
	50K-F	0.3487	0.3629	50K-G	0.3482	0.3583	
		0.3425	0.3579		0.3422	0.3533	
		0.3422	0.3533		0.3418	0.3483	
		0.3482	0.3583		0.3477	0.3530	
Reference Range:4910K~5120K							

CCT	Bin Code	CIE_x	CIE_y	Bin Code	CIE_x	CIE_y	
5700K	57K-A	0.3376	0.3616	57K-D	0.3371	0.3493	
		0.3292	0.3539		0.3321	0.3447	
		0.3292	0.3464		0.3320	0.3401	
		0.3321	0.3490		0.3293	0.3377	
		0.3321	0.3447		0.3294	0.3306	
		0.3371	0.3493		0.3366	0.3369	
	Reference Range:5310K~5700K						
	57K-B	0.3292	0.3539	57K-C	0.3215	0.3353	
		0.3207	0.3462		0.3222	0.3243	
		0.3215	0.3353		0.3294	0.3306	
		0.3262	0.3395		0.3293	0.3377	
		0.3261	0.3436		0.3263	0.335	
		0.3292	0.3464		0.3262	0.3395	
	Reference Range:5700K~6020K						
	57K-F	0.3321	0.3490	57K-G	0.3321	0.3447	
		0.3261	0.3436		0.3262	0.3395	
		0.3262	0.3395		0.3263	0.3350	
		0.3321	0.3447		0.3320	0.3401	
	Reference Range:5520K~5780K						

CCT	Bin Code	CIE_x	CIE_y	Bin Code	CIE_x	CIE_y	
6500K	65K-A	0.3205	0.3481	65K-D	0.3213	0.3371	
		0.3117	0.3393		0.3161	0.3320	
		0.3125	0.3328		0.3166	0.3281	
		0.3157	0.3360		0.3136	0.3251	
		0.3161	0.3320		0.3145	0.3187	
		0.3213	0.3371		0.3221	0.3261	
	Reference Range:6020K~6500K						
	65K-B	0.3117	0.3393	65K-C	0.3048	0.3209	
		0.3028	0.3304		0.3068	0.3113	
		0.3048	0.3209		0.3145	0.3187	
		0.3100	0.3259		0.3136	0.3251	
		0.3093	0.3297		0.3106	0.3222	
		0.3125	0.3328		0.31	0.3259	
	Reference Range:6500K~7050K						
	65K-F	0.3157	0.3360	65K-G	0.3161	0.3320	
		0.3093	0.3297		0.3100	0.3259	
		0.3100	0.3259		0.3106	0.3222	
		0.3161	0.3320		0.3166	0.3281	
	Reference Range:6300K~6690K						

Note:

1. The value is based on driving current by 150mA.
2. Tolerance of Chromaticity Coordinates: ± 0.01

Spectrum Distribution

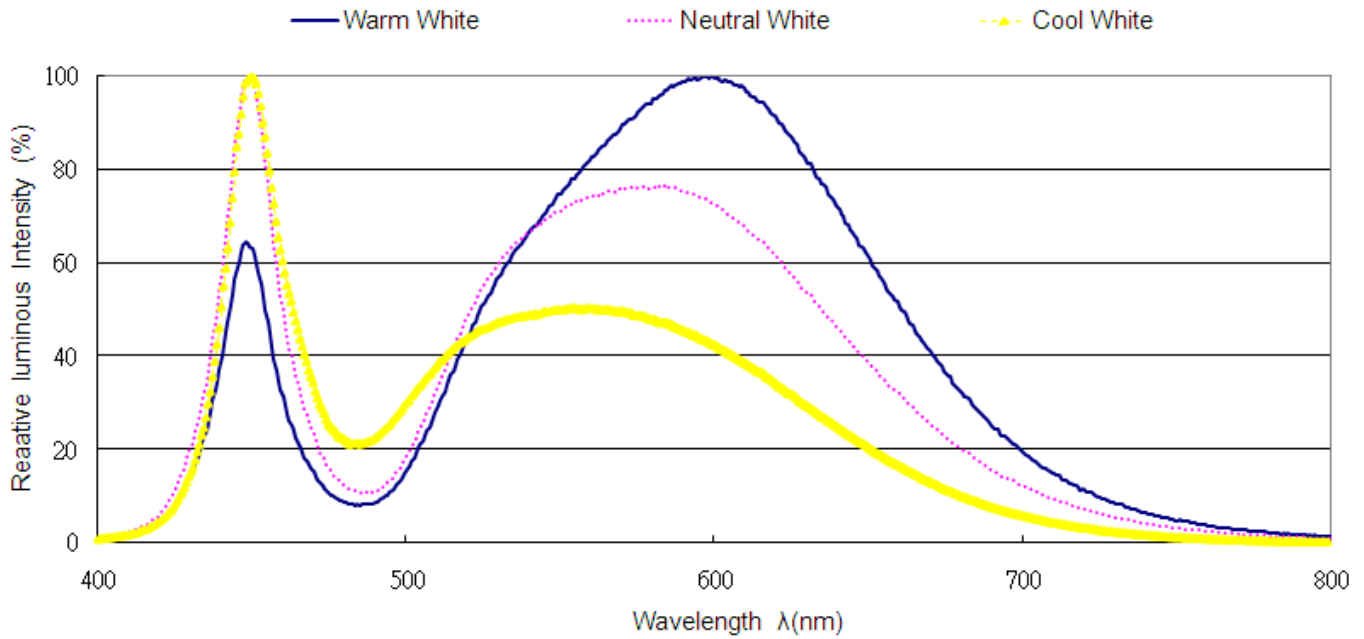

Typical Electro-Optical Characteristics Curves

Fig.1 – Forward Voltage Shift vs. Junction Temperature

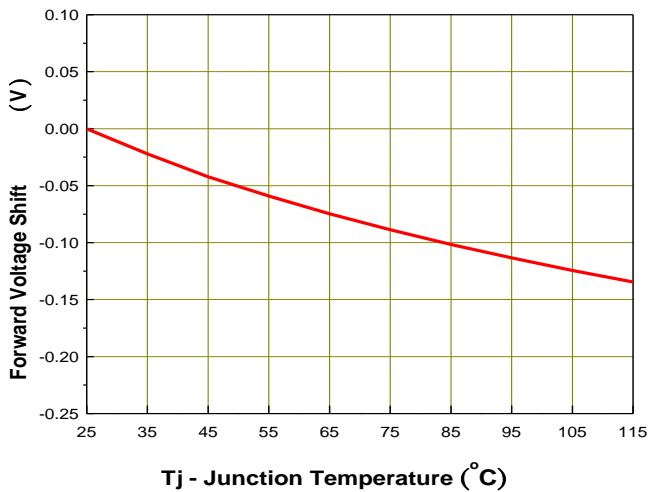
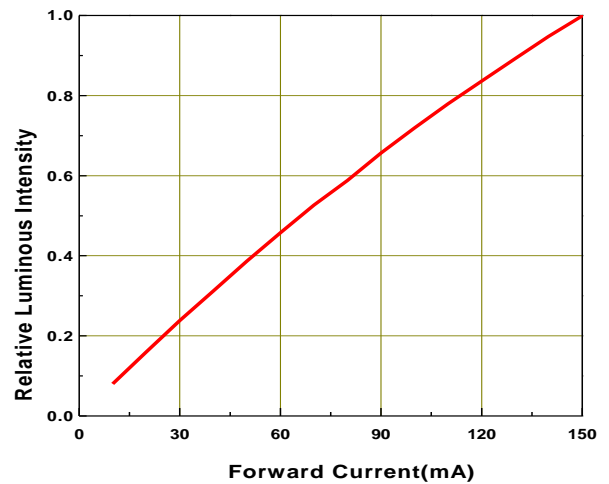

Fig.2 - Relative Luminous Intensity vs. Forward Current



Typical Electro-Optical Characteristics Curves

Fig.3 - Relative Luminous Intensity vs. Junction Temperature

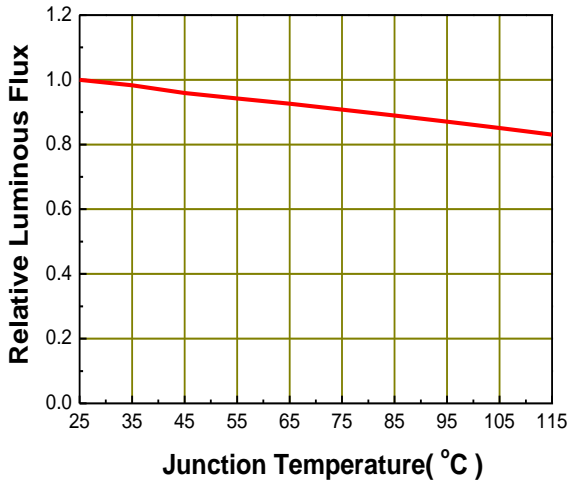

Fig.4 - Forward Current vs. Forward Voltage

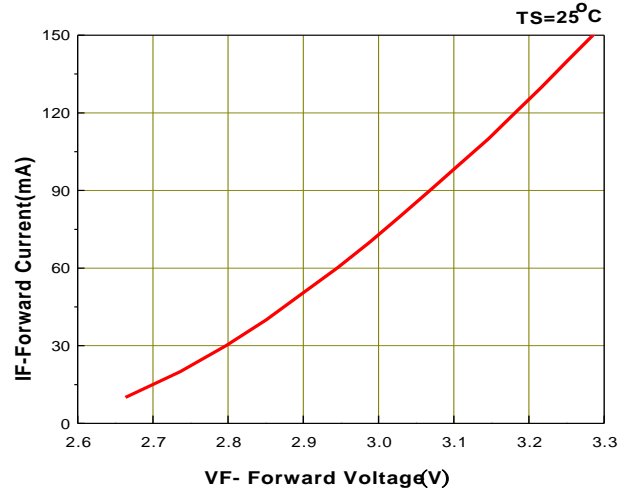

Fig.5 – Max. Driving Forward Current vs. Soldering Temperature

$R_{th\ j-s}=32^{\circ}C/W$

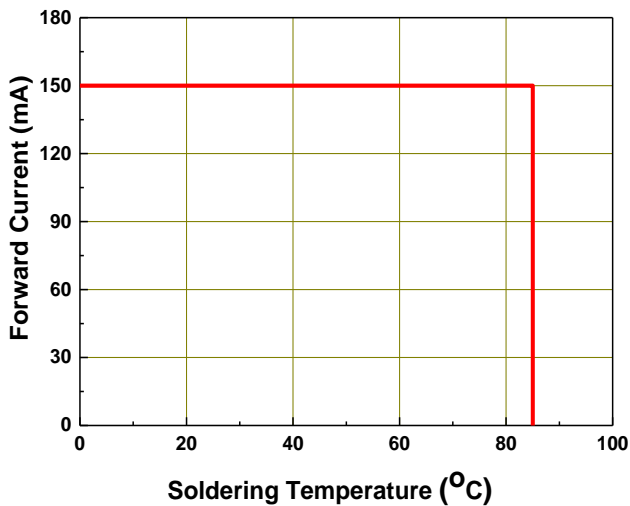
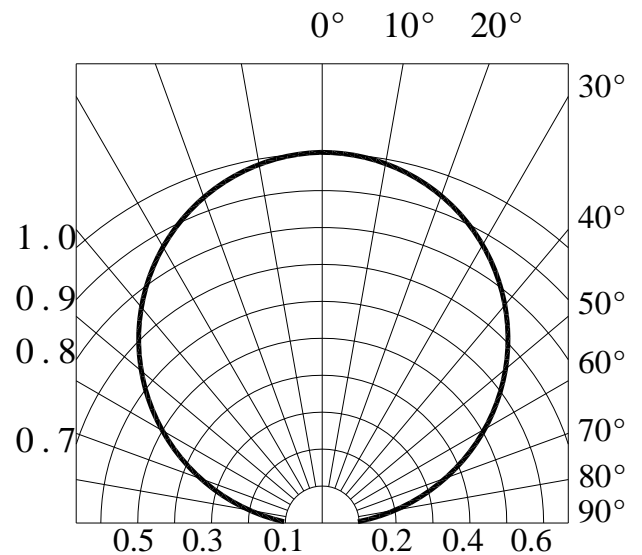
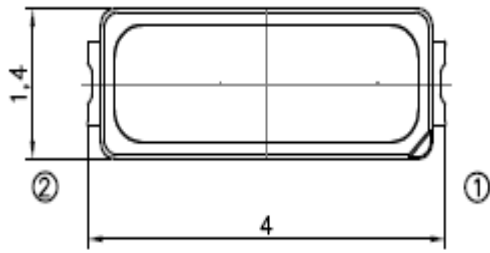

Fig.6 – Radiation Diagram



Package Dimension



Polarity

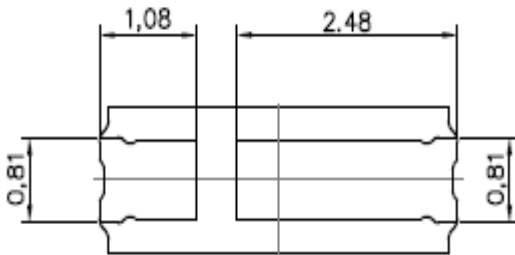
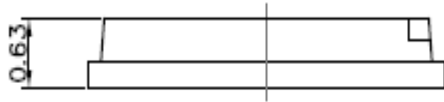

Bot. view

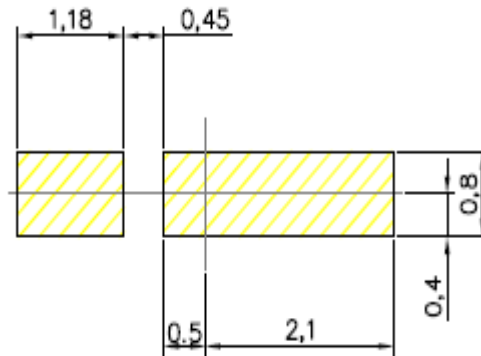

Soldering patterns

Note:
Tolerance unless mentioned is ± 0.2 mm; Unit = mm

Moisture Resistant Packing Materials

Label Explanation

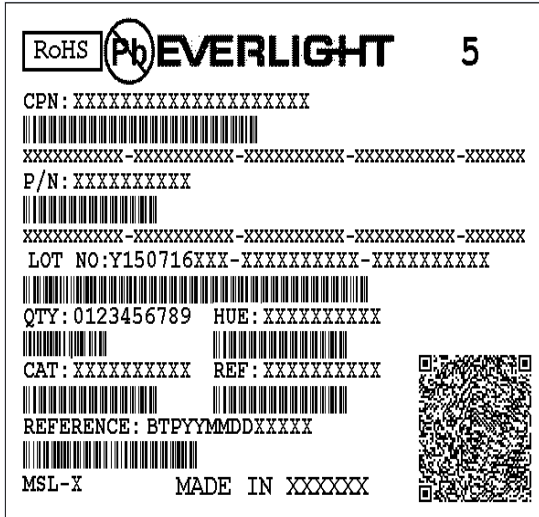

- CPN: Customer's Product Number
- P/N: Product Number
- QTY: Packing Quantity
- CAT: Luminous Intensity Rank
- HUE: Dom. Wavelength Rank
- REF: Forward Voltage Rank
- LOT No: Lot Number

Reel Dimensions

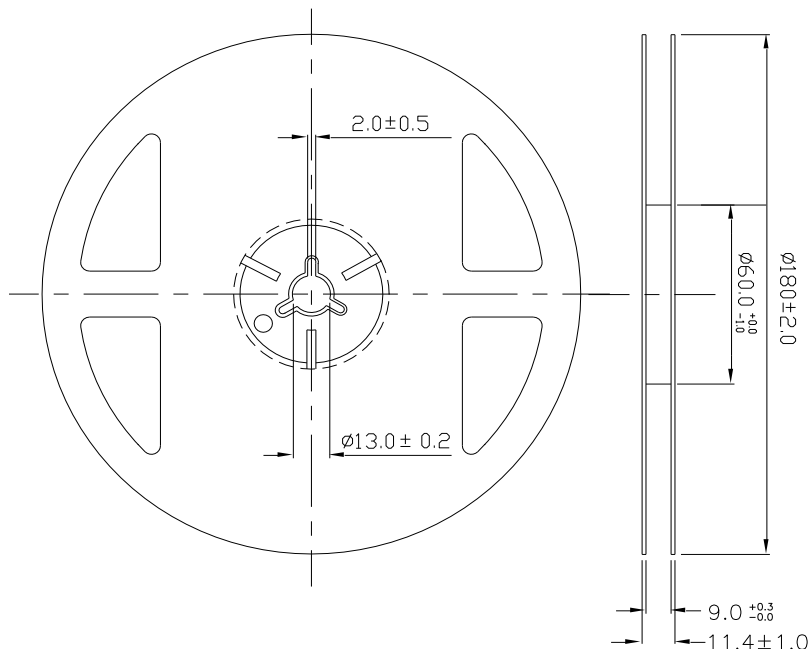

Note:
 Tolerances unless mentioned ± 0.1 mm. Unit = mm

Carrier Tape Dimensions: Loaded Quantity 500/1000/1500/2000/2500/3000/3500/4000 pcs Per Reel

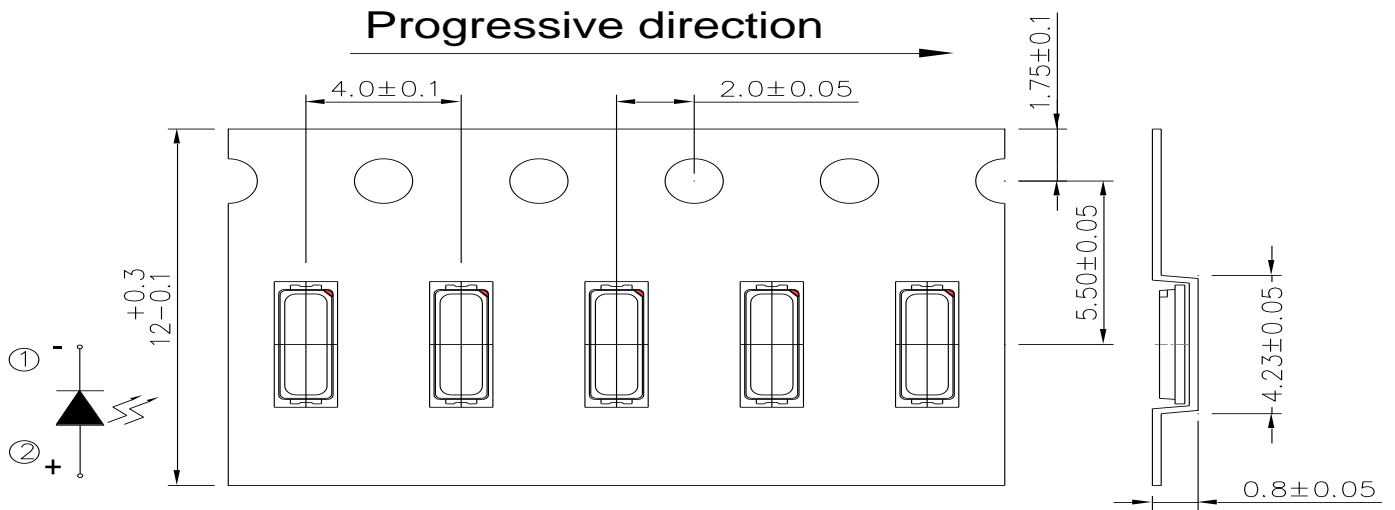

Note:
Tolerances unless mentioned ± 0.1 mm. Unit = mm

Moisture Resistant Packing Process

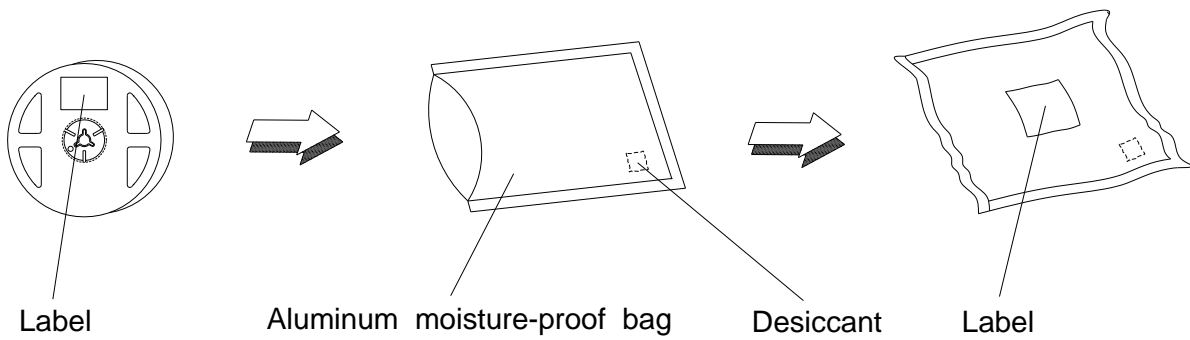

Reliability Test Items and Conditions

The reliability of products shall be satisfied with items listed below.
 Confidence level : 90%
 LTPD : 10%

No.	Items	Test Condition	Test Hours/Cycles	Sample Size	Ac/Re
1	Resistance to Solder Heat	Temp. : 260°C/10sec.	3 Times.	8 PCS.	0/1
2	Temperature Cycle	-40°C~100°C / Dwell time 30min	200 Cycles	8 PCS.	0/1
3	High Temperature/Humidity Life	Ta=85°C,85%RH, I _F = 150mA	1000 Hrs.	8 PCS.	0/1
4	Low Temperature Life	Ta=-40°C, I _F = 150 mA	1000 Hrs.	8 PCS.	0/1
5	High Temperature Life	Ta=60°C, I _F =150 mA	3000 Hrs.	8 PCS.	0/1
6	High Temperature Life	Ta=85°C, I _F =150 mA	3000 Hrs.	8 PCS.	0/1
7	Pulse	ON 30ms / OFF 2500ms	30000 CYCLES	8 PCS.	0/1
8	Thermal Shock	H : +100°C 20min ∫ 10 sec L : -10°C 20min	200 Cycles	8 PCS.	0/1
9	Power Temperature Cycle	H : +100°C 30min ∫ 5 min L : -40°C 30min I _F = 100 mA	200 Cycles	8 PCS.	0/1

Precautions for Use

1. Over-current-proof

Customer must apply resistors for protection; otherwise slight voltage shift will cause big current change (Burn out will happen).

2. Storage

2.1 Do not open moisture proof bag before the products are ready to use.

2.2 Before opening the package: The LEDs should be kept at 30°C or less and 90%RH or less.

2.3 After opening the package: The LED's floor life is 168 Hrs under 30°C or less and 60% RH or less. If unused LEDs remain, it should be stored in moisture proof packages.

2.4 If the moisture absorbent material (silica gel) has faded away or the LEDs have exceeded the storage time, baking treatment should be performed using the following conditions.

Baking treatment: 60±5°C for 24 hours.

3. Soldering Condition

3.1 Pb-free solder temperature profile

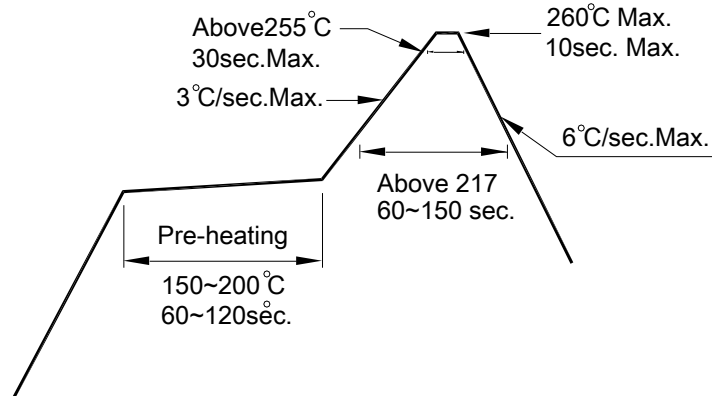

3.2 Reflow soldering should not be done more than two times.

3.3 When soldering, do not put stress on the LEDs during heating.

3.4 After soldering, do not warp the circuit board.

4. Soldering Iron

Each terminal is to go to the tip of soldering iron temperature less than 350°C for 3 seconds within once in less than the soldering iron capacity 25W. Leave two seconds and more intervals, and do soldering of each terminal. Be careful because the damage of the product is often started at the time of the hand solder.

5. Repairing

Repair should not be done after the LEDs have been soldered. When repairing is unavoidable, a double-head soldering iron should be used (as below figure). It should be confirmed beforehand whether the characteristics of the LEDs will or will not be damaged by repairing.

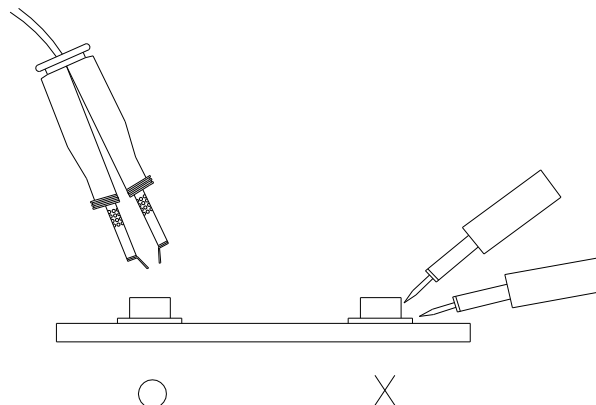

DISCLAIMER

1. EVERLIGHT reserves the right(s) on the adjustment of product material mix for the specification.
2. The product meets EVERLIGHT published specification for a period of twelve (12) months from date of shipment.
3. The graphs shown in this datasheet are representing typical data only and do not show guaranteed values.
4. When using this product, please observe the absolute maximum ratings and the instructions for using outlined in these specification sheets. EVERLIGHT assumes no responsibility for any damage resulting from the use of the product which does not comply with the absolute maximum ratings and the instructions included in these specification sheets.
5. These specification sheets include materials protected under copyright of EVERLIGHT. Reproduction in any form is prohibited without obtaining EVERLIGHT's prior consent.
6. This product is not intended to be used for military, aircraft, automotive, medical,