



### ELCS14G-NB5060J6J8293910-F3X

Received	
<input type="checkbox"/>	MASS PRODUCTION
<input checked="" type="checkbox"/>	PRELIMINARY
<input type="checkbox"/>	CUSTOMER DESIGN
DEVICE NO. :	
PAGE : 13	

Revised record		
REV.	DESCRIPTION	RELEASE DATE
1	New spec	May.09.2018

## ELCS14G-NB5060J6J8293910-F3X



### Features

- Feature of the device : small package with high efficiency
- Typical luminous flux@ 1A : 245 lm
- Optical efficiency@1A : 72.05 lm/W
- Binning Parameters : Brightness, Forward Voltage and Chromaticity
- Grouping parameter: total luminous flux, color coordinates.
- RoHS compliant & Pb free.
- The product itself will remain within RoHS compliant version.
- Compliance with EU REACH.
- Compliance Halogen Free .(Br <900 ppm ,Cl <900 ppm , Br+Cl < 1500 ppm).

### Applications

- Mobile Phone Camera Flash(Camera flash light /strobe light for mobile devices )
- Torch light for DV(Digital Video) application
- Indoor lighting applications
- Signal and symbol luminaries for orientation marker lights (e.g. steps, exit ways, etc.)
- TFT backlighting
- Exterior and interior illumination applications
- Decorative and Entertainment Lighting
- Exterior and interior automotive illumination

## Device Selection Guide

Chip Materials	Emitted Color
InGaN	Cool White

## Absolute Maximum Ratings

Parameter	Symbol	Rating	Unit
DC Forward Current (Torch Mode)	$I_F$	350	mA
Peak Pulse Current (400 ms on / 3600 ms off / 30000 cycle )	$I_{Pulse}$	1000	mA
ESD Resistance (JEDEC 3b)	$V_B$	2	V
Reverse Voltage	$V_R$	Note 1	V
Junction Temperature	$T_J$	145	°C
Operating Temperature	$T_{Opr}$	-40 ~ +85	°C
Storage Temperature	$T_{Stg}$	-40 ~ +100	°C
Soldering Temperature	$T_{Sol}$	260	°C
Allowable Reflow Cycles	n/a	2	Cycles
Viewing Angle <sub>(2)</sub>	$2\theta_{1/2}$	120	Deg
Thermal resistance	$R_{th}$	8.5°	C/W

### Notes:

1. The CS series LEDs are not designed for reverse bias used.
2. View angle measurement tolerance $\pm 5^\circ$
3. Avoid operating CS series LEDs at maximum operating temperature exceed 1 hour.
4. All specification are assured by reliability test for 1000hr, IV degradation less than 30%.
5. All reliability items are tested under good thermal management with 1.0x 1.0 cm<sup>2</sup> MCPCB.

## JEDEC Moisture Sensitivity

Level	Floor Life		Soak Requirements Standard	
	Time ( hours )	Conditions	Time ( hours )	Conditions
1	Unlimited	$\leq 30^\circ\text{C} / 85\% \text{ RH}$	168 (+5/-0)	$85^\circ\text{C} / 85\% \text{ RH}$

## Electro-Optical Characteristics (Ts=25°C)

Parameter	Symbol	Min.	Typ.	Max.	Unit	Condition
Luminous Flux <sup>(1)</sup>	I <sub>v</sub>	220	245	----	lm	
Forward Voltage <sup>(2)(3)</sup>	V <sub>F</sub>	2.95	----	3.95	V	I <sub>F</sub> =1000mA
Color Temperature	CCT	5000	----	6000	K	

## Forward Voltage Binning

Bin	Symbol	Min.	Typ.	Max.	Unit	Condition
2932	V <sub>F</sub>	2.95	----	3.25	V	I <sub>F</sub> =1000mA
3235	V <sub>F</sub>	3.25	----	3.55		
3539	V <sub>F</sub>	3.55	----	3.95		

## Luminous Flux Binning

Bin	Symbol	Min.	Typ.	Max.	Unit	Condition
J6	I <sub>v</sub>	220	----	250	lm	I <sub>F</sub> =1000mA
J7	I <sub>v</sub>	250	----	300		
J8	I <sub>v</sub>	300	----	330		

### Notes:

1. Luminous Flux, illuminance measurement tolerance : ±10%
2. Forward voltage measurement tolerance : ±0.1V
3. Electric and optical data is tested at 50 ms pulse condition.
4. Low current voltage measurement tolerance: ±10%
5. Temperature of solder pad : 25°C

Cool White Bin Structure

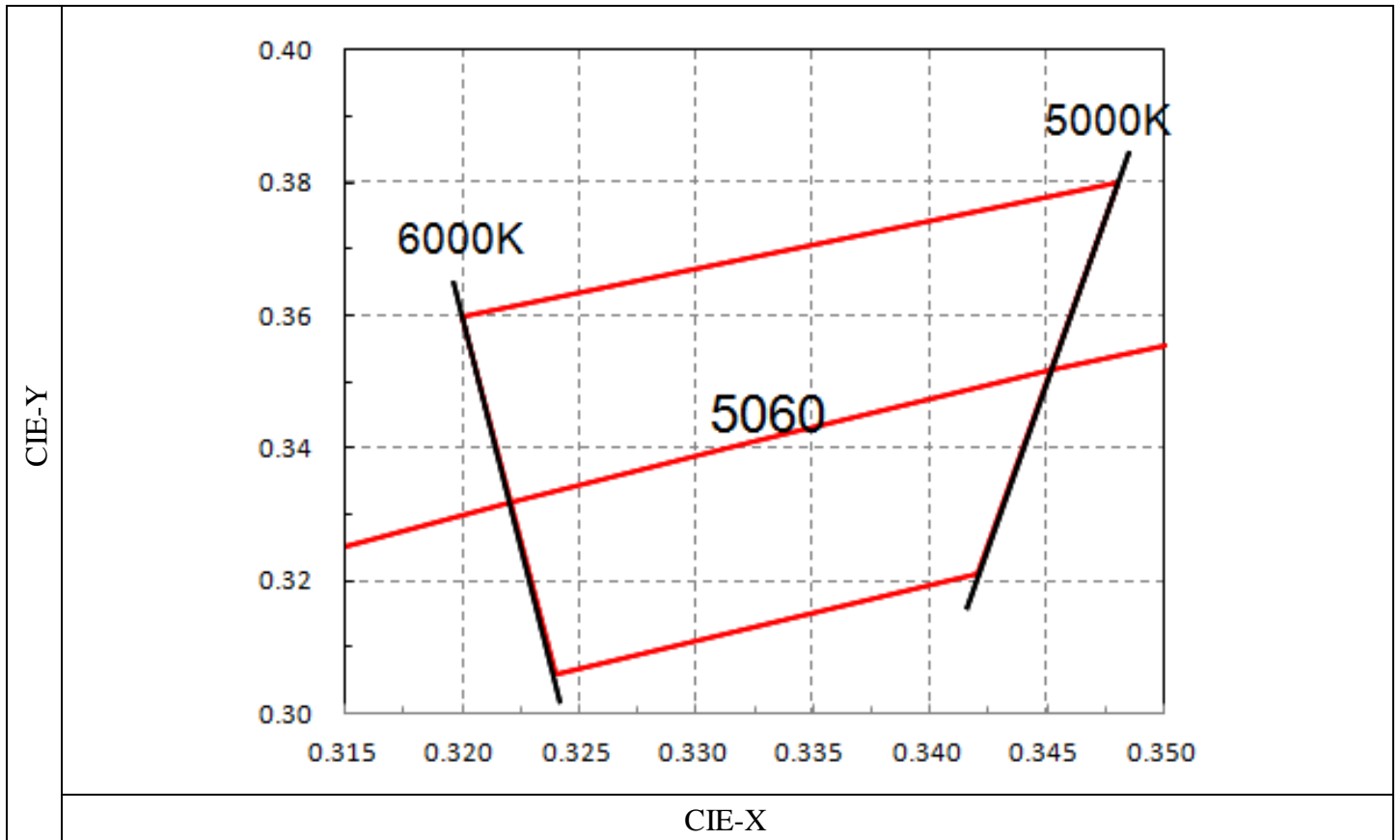

Bin	CIE-X	CIE-Y	Reference Range
5060	0.3200	0.3600	5000 ~ 6000K
	0.3480	0.3800	
	0.3420	0.3210	
	0.3240	0.3060	

Notes:

1. Color coordinates measurement allowance :  $\pm 0.01$
2. Color bins are defined at IF=1000mA operation.

## Typical Electro-Optical Characteristics Curves

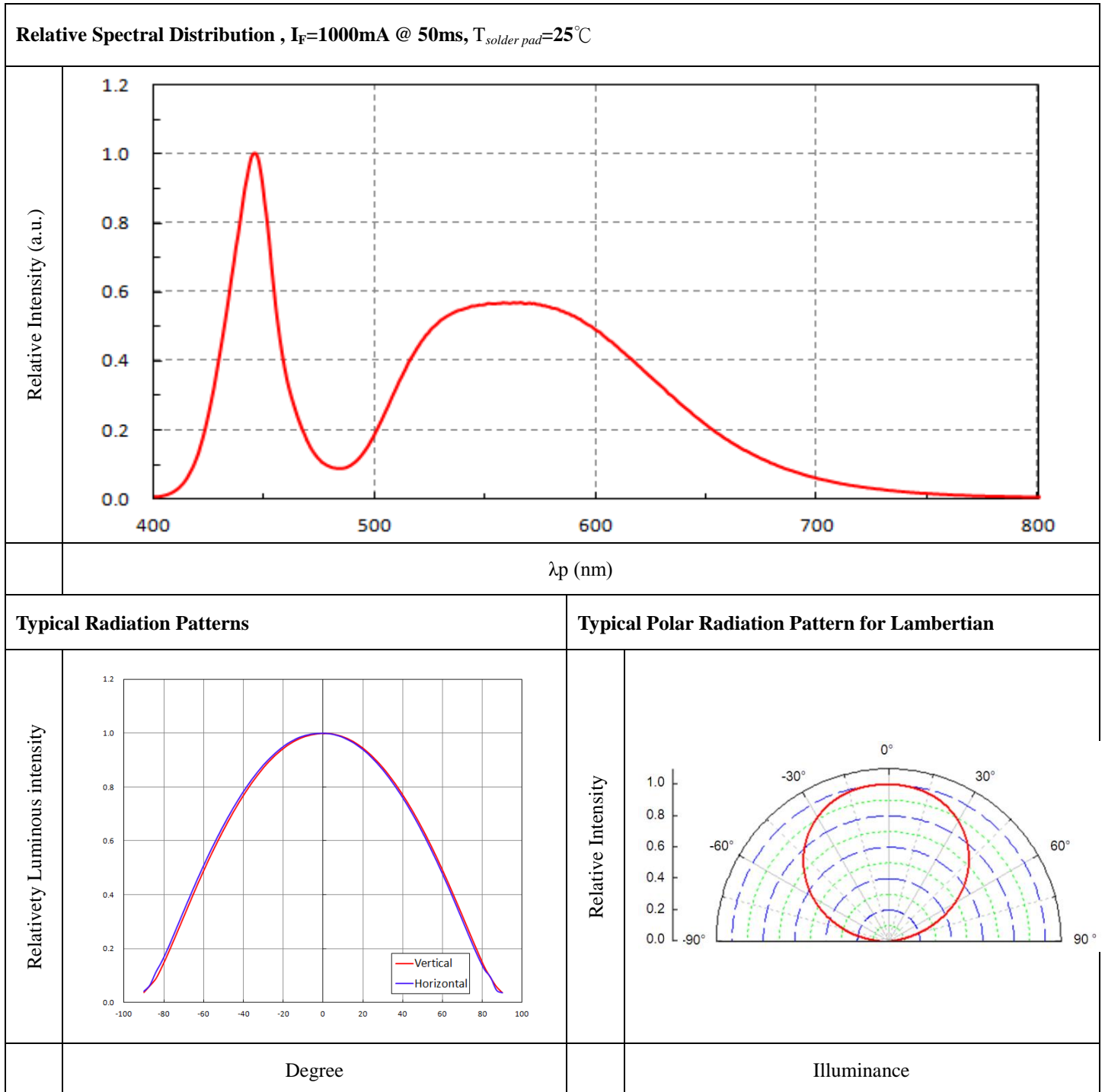

**Notes:**

1.  $2\theta_{1/2}$  is the off axis from lamp centerline where the luminous intensity is 1/2 of the peak value.
2. View angle tolerance is  $\pm 5^\circ$

Forward Voltage vs. Forward Current ( $T_{\text{solder pad}}=25^{\circ}\text{C}$ )		Relative Luminous Flux vs. Forward Current ( $T_{\text{solder pad}}=25^{\circ}\text{C}$ )	
Forward Voltage (V)		Relative Luminous Flux	
	Forward Current (mA @ 50ms)		Forward Current (mA @ 50ms)

CCT vs. Forward Current ( $T_{\text{soldering pad}}=25^{\circ}\text{C}$ )	
Correlated Color Temperature(K)	
	Forward Current (mA @ 50ms)

**Notes:**

1. All correlation data is tested under superior thermal management with 1 x 1 cm<sup>2</sup> MCPCB.

## Package Dimension

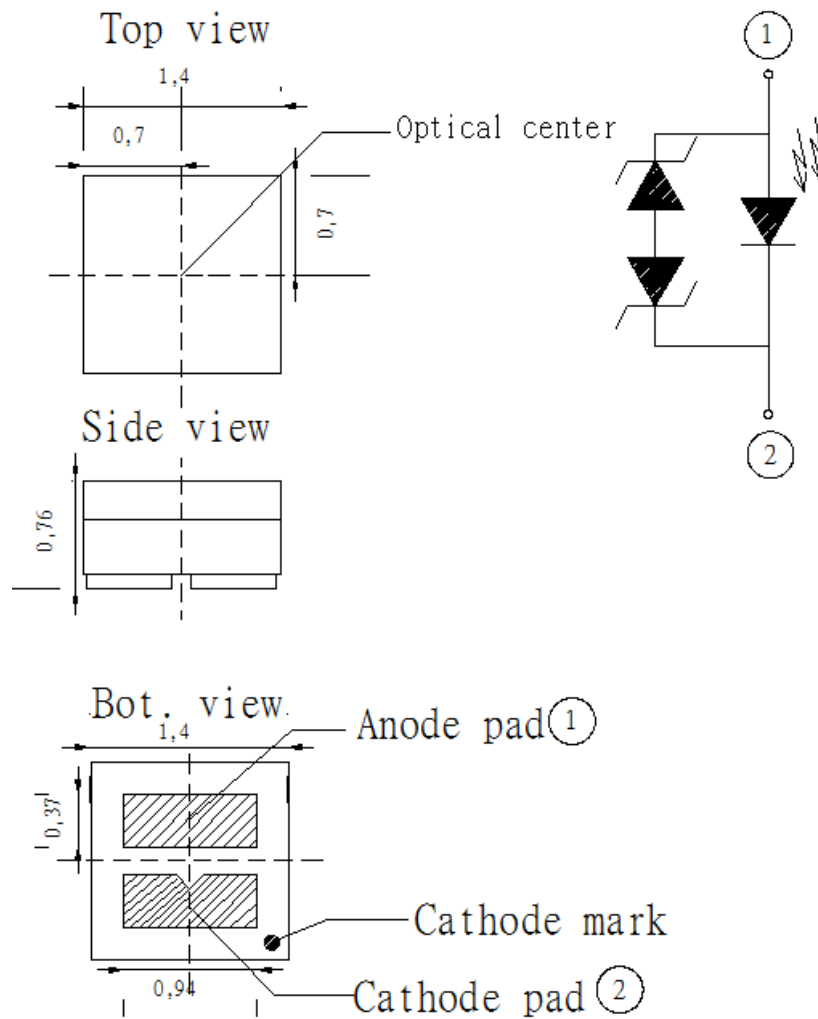

### Notes:

1. Dimensions are in millimeters.



## Moisture Resistant Packing Materials

### Product Labeling



- CPN:Customer's Product Number
- P/N:Everlight Product Number
- LOT NO:Lot Number
- QTY:Packing Quantity
- CAT:Luminous Flux (Brightness) Bin
- HUE:Color Bin
- REF:Forward Voltage Bin
- REFERENCE:Reference
- MSL-X:MSL Level

### Carrier Tape Dimensions: Loaded Quantity 2000 pcs Per Reel

(Minimum Package Quantity :1000 PCS)

**TBD**

#### Notes:

1. Dimensions are in millimeters.

### Emitter Reel Dimensions

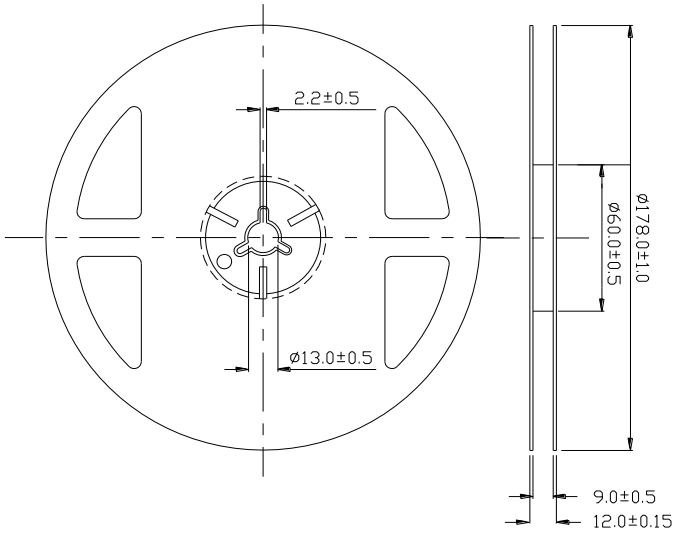

#### Notes:

1. Dimensions are in millimeters.

### Moisture Resistant Packing Process

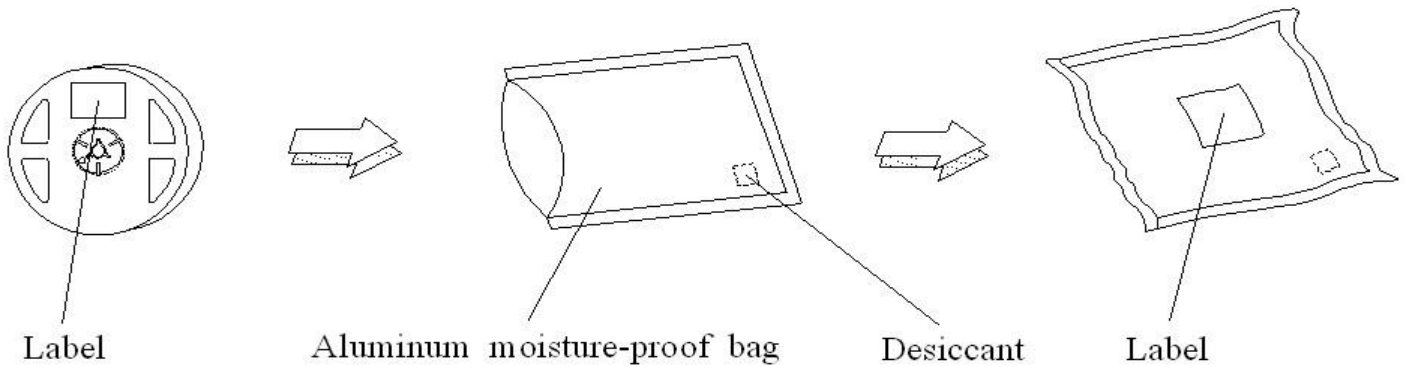

## Reflow Soldering Characteristics

### Soldering and Handling

#### 1. Over-current-proof

Though CS series has conducted ESD protection mechanism, customers must not use the device in reverse and should apply resistors for extra protection. Otherwise, slight voltage shift may cause enormous current shift and burn out failure would happen.

#### 2. Storage

- 2.1 Do not open the moisture proof bag before the products are ready to use.
- 2.2 Before opening the package, the LEDs should be stored at temperature less than 30°C and relative humidity less than 90%
- 2.3 After opening the package, the LEDs should be stored at temperature less than 30°C and relative humidity less than 85%.
- 2.4 If the moisture absorbent material (silicone gel) has faded away or the LEDs have exceeded the storage time, baking treatment should be implemented based on the following conditions: Pre-curing at 60±5°C for 24 hours.

#### 3. Thermal Management

- 3.1 For maintaining the high flux output and achieving reliability, CS series LEDs should be mounted on a metal core printed circuit board (MCPCB), with proper thermal connection to dissipate approximately 1W to 5W of thermal energy under normal operation.
- 3.2 Sufficient thermal management must be conducted, or the die junction temperature will be over the limit under large electronic driving and LEDs lifetime will decrease critically.
- 3.3 When operating, the solder pad temperature ( or the board temperature nearby the LED) must controlled under 70°C.

#### 4. Soldering Condition

##### 4.1 Soldering Pad

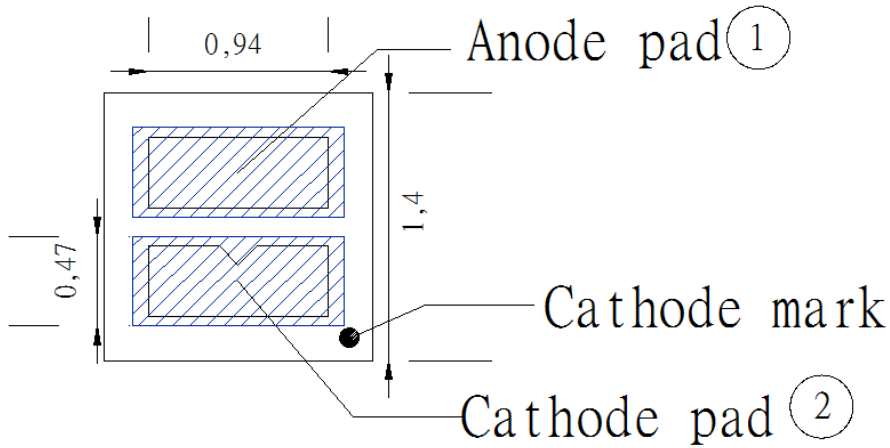

### Soldering pattern

#### 4.2 For Reflow Process

##### 4.2.1 Lead reflow soldering temperature profile

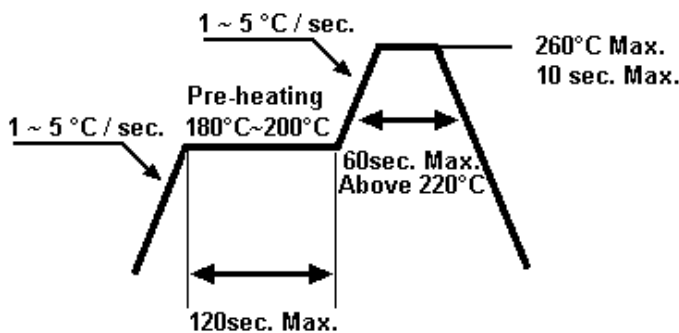

4.2.2 Reflow soldering should not be done more than two times.

4.2.3 While soldering, do not put stress on the LEDs during heating.

4.2.4 After soldering, do not warp the circuit board.

## **DISCLAIMER**

1. EVERLIGHT reserves the right(s) on the adjustment of product material mix for the specification.
2. The product meets EVERLIGHT published specification for a period of twelve (12) months from date of shipment.
3. The graphs shown in this datasheet are representing typical data only and do not show guaranteed values.
4. When using this product, please observe the absolute maximum ratings and the instructions for using outlined in these specification sheets. EVERLIGHT assumes no responsibility for any damage resulting from the use of the product which does not comply with the absolute maximum ratings and the instructions included in these specification sheets.
5. These specification sheets include materials protected under copyright of EVERLIGHT. Reproduction in any form is prohibited without obtaining EVERLIGHT's prior consent.
6. This product is not intended to be used for military, aircraft, automotive, medical, life sustaining or life saving applications or any other application which can result in human injury or death. Please contact authorized Everlight sales agent for special application request.