

## R-6 Plastic-Encapsulate Diodes

### 10A05 THRU 10A10 General Purpose Rectifier Diodes

#### Features

- $I_{F(AV)}$  10A
- $V_{RRM}$  50V-1000V
- High surge current capability
- Polarity: Color band denotes cathode

#### Applications

- Rectifier

#### Marking

- 10AX
- X : From 05 To 10

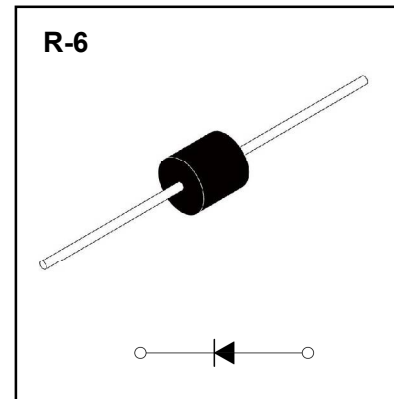

#### Limiting Values(Absolute Maximum Rating)

Item	Symbol	Unit	Test Conditions	10A						
				05	1	2	4	6	8	10
Repetitive Peak Reverse Voltage	$V_{RRM}$	V		50	100	200	400	600	800	1000
Maximum RMS Voltage	$V_{RMS}$	V		35	70	140	280	420	560	700
Average Forward Current	$I_{F(AV)}$	A	60Hz Half-sine wave, Resistance load, $T_L=60^\circ\text{C}$	10.0						
Surge(Non-repetitive)Forward Current	$I_{FSM}$	A	60Hz Half-sine wave, 1 cycle, $T_a=25^\circ\text{C}$	400						
Junction Temperature	$T_J$	$^\circ\text{C}$		-55 ~ +150						
Storage Temperature	$T_{STG}$	$^\circ\text{C}$		-55 ~ +150						

#### Electrical Characteristics (T=25°C Unless otherwise specified)

Item	Symbol	Unit	Test Condition	Max	
Peak Forward Voltage	$V_F$	V	$I_F=10.0\text{A}$	1.0	
Peak Reverse Current	$I_{RRM1}$	$\mu\text{A}$	$V_{RM}=V_{RRM}$	$T_a=25^\circ\text{C}$	10.0
	$I_{RRM2}$			$T_a=100^\circ\text{C}$	100
Typical junction capacitance	$C_J$	pF	Measured at 1MHz and applied reverse voltage of 4.0V D.C.	150	
Thermal Resistance(Typical)	$R_{\theta J-A}$	$^\circ\text{C}/\text{W}$	Between junction and ambient	10	
	$R_{\theta J-L}$		Between junction and Lead	5	

#### Notes:

Thermal resistance from junction to ambient at 0.375" (9.5mm)lead length,P.C.B. mounted

# Typical Characteristics

FIG.1: FORWARD CURRENT DERATING CURVE

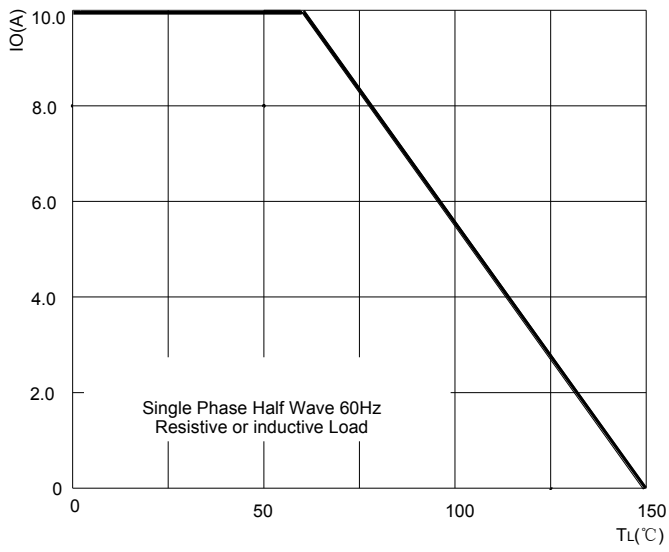

FIG.2: MAXIMUM NON-REPETITIVE FORWARD SURGE CURRENT

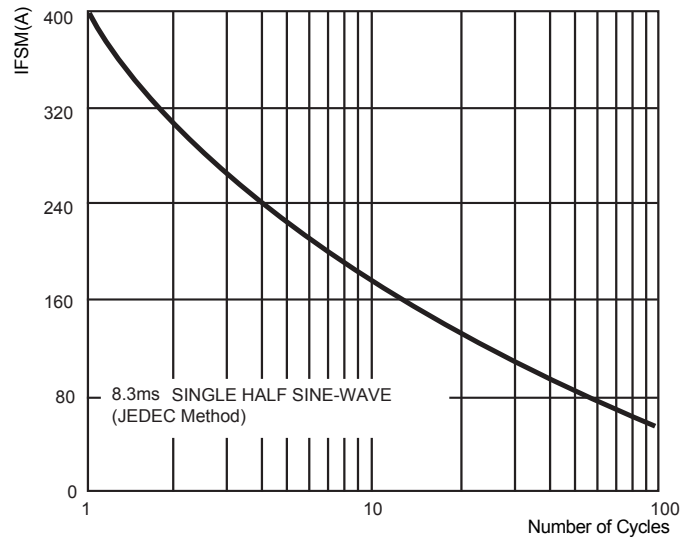

FIG.3: TYPICAL FORWARD CHARACTERISTICS

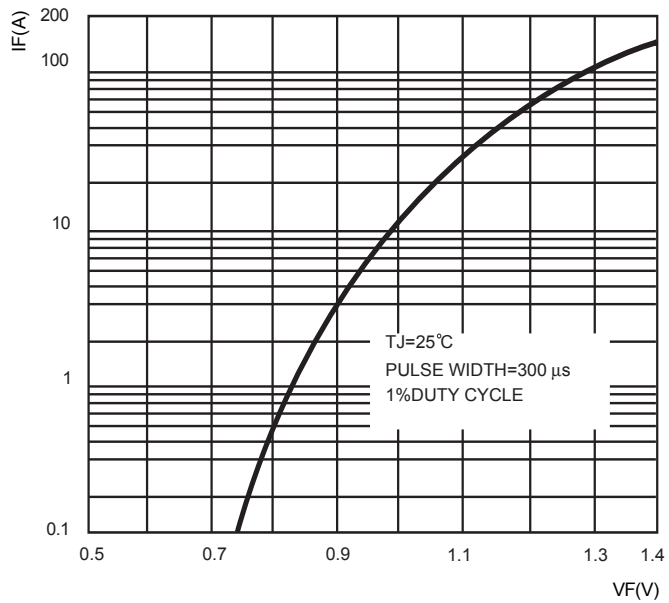
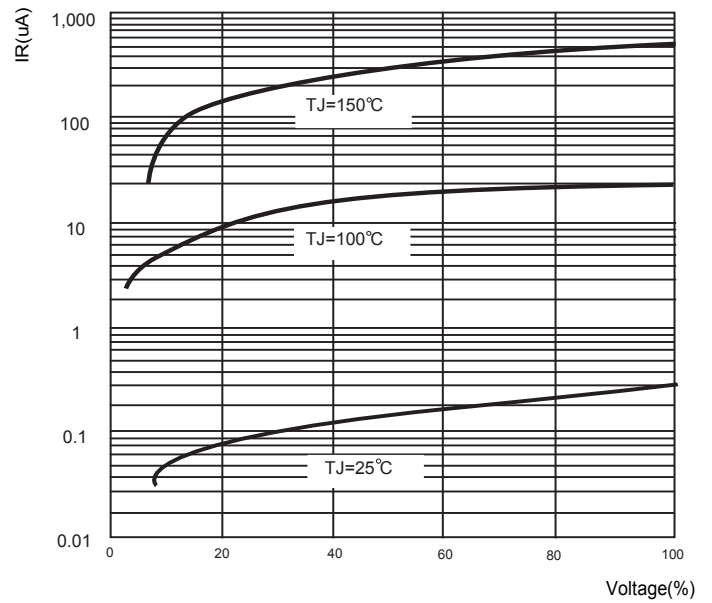
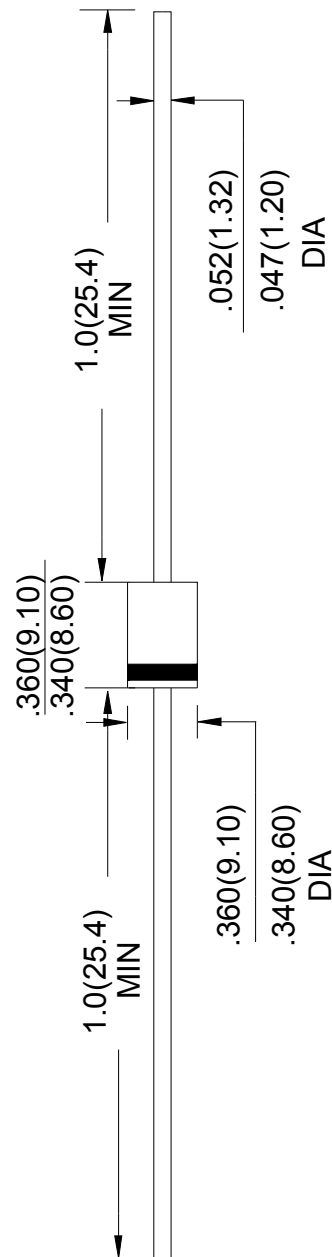

FIG.4: TYPICAL REVERSE CHARACTERISTICS



## R-6 Package Outline Dimensions



Unit: in inches (millimeters)

### NOTICE

JSCJ reserves the right to make modifications, enhancements, improvements, corrections or other changes without further notice to any product herein. JSCJ does not assume any liability arising out of the application or use of any product described herein.

# Ammo Box Packaging Specifications For Axial Lead Rectifiers

Axial lead devices are packed in accordance with EIA standard RS-296-D and specifications given below

COMPONENT OUTLINE	COMPONENT PITCH A	INNER TAPE PITCH B	CUMULATIVE PITCH TOLERANCE
	$\pm 0.5\text{mm}(.020'')$	$+0.5\text{mm}(.020'')$	
R-1	5.0mm	26.0mm	2.0mm/20pitch
R-1	5.0mm	52.4mm	2.0mm/10pitch
A-405	5.0mm	26.0mm	2.0mm/20pitch
A-405	5.0mm	52.4mm	2.0mm/10pitch
DO-34/DO-35	5.0mm	26.0mm	2.0mm/20pitch
DO-34/DO-35	5.0mm	52.4mm	2.0mm/10pitch
DO-41	5.0mm	26.0mm	2.0mm/20pitch
DO-41	5.0mm	52.4mm	2.0mm/10pitch
DO-15	5.0mm	52.4mm	2.0mm/10pitch
DO-27	10.0mm	52.4mm	2.0mm/10pitch
R-6	10.0mm	52.4mm	2.0mm/10pitch

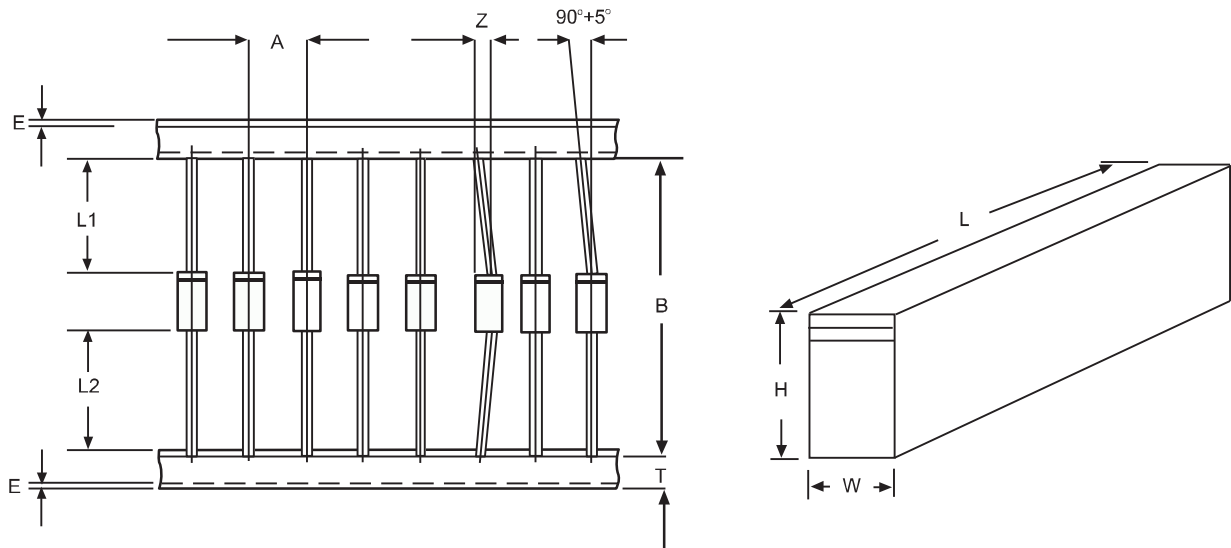

ITEM	SYMBOL	SPECIFICATIONS(mm)	SPECIFICATIONS(inch)
Component alignment	Z	1.2max	0.048max
Tape width	T	$6.0\pm 0.4$	$0.236\pm 0.016$
Exposed adhesive	E	0.8max	0.032max
Body eccentricity	IL1-L2I	1.0max	0.040max
Box length	L	$255.0\pm 5.0$	$10.04\pm 0.197$
Box width	W	$78.0\pm 5.0$	$3.07\pm 0.197$
Box height	H	$150.0\pm 5.0$	$5.91\pm 0.197$

NOTE: Each component lead shall be sandwiched between tapes for A minimum of 3.2mm(0.126'')