

DO-41 Plastic-Encapsulate Diodes

P4KE SERIES Transient Voltage Suppressor Diodes

Features

- P_{PP} 400W
- V_{RWM} 6.8V- 550V
- Glass passivated chip

Applications

- Clamping Voltage

Marking

- P4KE XXA/CA

XX : From 6.8 To 550

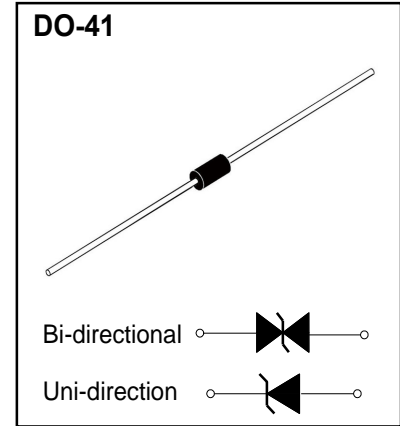

Limiting Values (Absolute Maximum Rating)

Item	Symbol	Unit	Conditions	Max
Peak pulse power dissipation	P _{PPM}	W	with a 10/1000us waveform	400
Peak pulse current (1)	I _{PPM}	A	with a 10/1000us waveform	See Next Table
Power dissipation	P _D	W	On infinite heat sink at T _L =75°C	1.5
Peak forward surge current(2)	I _{FSM}	A	8.3 ms single half sine-wave unidirectional only	40
Operation Junction and Storage Temperature Range	T _J , T _{STG}	°C		-55 ~ +150

Electrical Characteristics (T_a=25°C Unless otherwise specified)

Item	Symbol	Unit	Conditions	Max
Maximum instantaneous forward Voltage (3)	V _F	V	at 25A for unidirectional only	3.5/5.0
Thermal resistance	R _{θJL}	°C/W	junction to lead	66
	R _{θJA}	°C/W	junction to ambient, L _{Lead} = 10 mm	100

Notes:

V_F = 3.5 V for P4KE220(A) and below; V_F = 5.0 V for P4KE250(A) and above

Electrical Characteristics ($T_A=25^{\circ}\text{C}$ unless otherwise noted)

Part Number(Uni)	Part Number(Bi)	Breakdown Voltage $V_{BR}@I_T$			Maximum Reverse Leakage $I_R@V_{WM}(\mu A)$	Working Peak Reverse Voltage $V_{RWM}(V)$	Maximum Reverse Surge Current IPP (A)	Maximum Clamping Voltage $V_c@I_{PP}(V)$	Maximum Temperature Coefficient of $V_{BR}(\%/^{\circ}\text{C})$
		Min(V)	Max (V)	$I_T(\text{mA})$					
P4KE6.8	P4KE6.8C	6.12	7.48	10	1000	5.5	37	10.8	0.057
P4KE6.8A	P4KE6.8CA	6.45	7.14	10	1000	5.8	38.1	10.5	0.057
P4KE7.5	P4KE7.5C	6.75	8.25	10	500	6.05	34.2	11.7	0.061
P4KE7.5A	P4KE7.5CA	7.13	7.88	10	500	6.4	35.4	11.3	0.061
P4KE8.2	P4KE8.2C	7.38	9.02	10	200	6.63	32	12.5	0.065
P4KE8.2A	P4KE8.2CA	7.79	8.61	10	200	7.02	33.1	12.1	0.060
P4KE9.1	P4KE9.1C	8.19	10	1	50	7.37	29	13.8	0.068
P4KE9.1A	P4KE9.1CA	8.65	9.55	1	50	7.78	29.9	13.4	0.068
P4KE10	P4KE10C	9	11	1	10	8.1	26.7	15	0.073
P4KE10A	P4KE10CA	9.5	10.5	1	10	8.55	27.6	14.5	0.073
P4KE11	P4KE11C	9.9	12.1	1	5	8.92	24.7	16.2	0.075
P4KE11A	P4KE11CA	10.5	11.6	1	5	9.4	25.6	15.6	0.075
P4KE12	P4KE12C	10.8	13.2	1	1	9.72	23.1	17.3	0.076
P4KE12A	P4KE12CA	11.4	12.6	1	1	10.2	24	16.7	0.078
P4KE13	P4KE13C	11.7	14.3	1	1	10.5	21.1	19	0.081
P4KE13A	P4KE13CA	12.4	13.7	1	1	11.1	22	18.2	0.081
P4KE15	P4KE15C	13.5	16.5	1	1	12.1	18.2	22	0.084
P4KE15A	P4KE15CA	14.3	15.8	1	1	12.8	18.9	21.2	0.084
P4KE16	P4KE16C	14.4	17.6	1	1	12.9	17	23.5	0.086
P4KE16A	P4KE16CA	15.2	16.8	1	1	13.6	17.8	22.5	0.086
P4KE18	P4KE18C	16.2	19.8	1	1	14.5	15.1	26.5	0.088
P4KE18A	P4KE18CA	17.1	18.9	1	1	15.3	15.9	25.2	0.088
P4KE20	P4KE20C	18	22	1	1	16.2	13.7	29.1	0.090
P4KE20A	P4KE20CA	19	21	1	1	17.1	14.4	27.7	0.090
P4KE22	P4KE22C	19.8	24.2	1	1	17.8	12.5	31.9	0.092
P4KE22A	P4KE22CA	20.9	23.1	1	1	18.8	13.1	30.6	0.092
P4KE24	P4KE24C	21.6	26.4	1	1	19.4	11.5	34.7	0.094
P4KE24A	P4KE24CA	22.8	25.2	1	1	20.5	12	33.2	0.094
P4KE27	P4KE27C	24.3	29.7	1	1	21.8	10.2	39.1	0.096
P4KE27A	P4KE27CA	25.7	28.4	1	1	23.1	10.7	37.5	0.096
P4KE30	P4KE30C	27	33	1	1	24.3	9.2	43.5	0.097
P4KE30A	P4KE30CA	28.5	31.5	1	1	25.6	9.7	41.4	0.097
P4KE33	P4KE33C	29.7	36.3	1	1	26.8	8.4	47.7	0.098
P4KE33A	P4KE33CA	31.4	34.7	1	1	28.2	8.8	45.7	0.098
P4KE36	P4KE36C	32.4	39.6	1	1	29.1	7.7	52	0.099
P4KE36A	P4KE36CA	34.2	37.8	1	1	30.8	8	49.9	0.099

Electrical Characteristics ($T_A=25^\circ\text{C}$ unless otherwise noted)

Part Number(Uni)	Part Number(Bi)	Breakdown Voltage $V_{BR}@I_T$			Maximum Reverse Leakage $I_R @ V_{WM} (\mu A)$	Working Peak Reverse Voltage $V_{RWM} (V)$	Maximum Reverse Surge Current IPP (A)	Maximum Clamping Voltage $V_c @ I_{PP} (V)$	Maximum Temperature Coefficient of $V_{BR} (\%/^\circ\text{C})$
		Min(V)	Max (V)	IT(mA)					
P4KE39	P4KE39C	35.1	42.9	1	1	31.6	7.1	56.4	0.100
P4KE39A	P4KE39CA	37.1	41	1	1	33.3	7.4	53.9	0.100
P4KE43	P4KE43C	38.7	47.3	1	1	34.8	6.5	61.9	0.101
P4KE43A	P4KE43CA	40.9	45.2	1	1	36.8	6.7	59.3	0.101
P4KE47	P4KE47C	42.3	51.7	1	1	38.1	5.9	67.8	0.101
P4KE47A	P4KE47CA	44.7	49.4	1	1	40.2	6.2	64.8	0.101
P4KE51	P4KE51C	45.9	56.1	1	1	41.3	5.4	73.5	0.102
P4KE51A	P4KE51CA	48.5	53.6	1	1	43.6	5.7	70.1	0.102
P4KE56	P4KE56C	50.4	61.6	1	1	45.4	5	80.5	0.103
P4KE56A	P4KE56CA	53.2	58.8	1	1	47.8	5.2	77	0.103
P4KE62	P4KE62C	55.8	68.2	1	1	50.2	4.5	89	0.104
P4KE62A	P4KE62CA	58.9	65.1	1	1	53	4.7	85	0.104
P4KE68	P4KE68C	61.2	74.8	1	1	55.1	4.1	98	0.104
P4KE68A	P4KE68CA	64.6	71.4	1	1	58.1	4.3	92	0.104
P4KE75	P4KE75C	67.5	82.5	1	1	60.7	3.7	108	0.105
P4KE75A	P4KE75CA	71.3	78.8	1	1	64.1	3.9	103	0.105
P4KE82	P4KE82C	73.8	90.2	1	1	66.4	3.4	118	0.105
P4KE82A	P4KE82CA	77.9	86.1	1	1	70.1	3.5	113	0.105
P4KE91	P4KE91C	81.9	100	1	1	73.7	3.1	131	0.106
P4KE91A	P4KE91CA	86.5	95.5	1	1	77.8	3.2	125	0.106
P4KE100	P4KE100C	90	110	1	1	81	2.8	144	0.106
P4KE100A	P4KE100CA	95	105	1	1	85.5	2.9	137	0.106
P4KE110	P4KE110C	99	121	1	1	89.2	2.5	158	0.107
P4KE110A	P4KE110CA	105	116	1	1	94	2.6	152	0.107
P4KE120	P4KE120C	108	132	1	1	97.2	2.3	173	0.107
P4KE120A	P4KE120CA	114	126	1	1	102	2.4	165	0.107
P4KE130	P4KE130C	117	143	1	1	105	2.1	187	0.107
P4KE130	P4KE130CA	124	137	1	1	111	2.2	179	0.107
P4KE150	P4KE150C	135	165	1	1	121	1.9	215	0.108
P4KE150A	P4KE150CA	143	158	1	1	128	1.9	207	0.108
P4KE160	P4KE160C	144	176	1	1	130	1.7	230	0.108
P4KE160A	P4KE160CA	152	168	1	1	136	1.8	219	0.108
P4KE170	P4KE170C	153	187	1	1	138	1.6	244	0.108
P4KE170A	P4KE170CA	162	179	1	1	145	1.7	234	0.108
P4KE180	P4KE180C	162	198	1	1	146	1.6	258	0.108
P4KE180A	P4KE180CA	171	189	1	1	154	1.6	246	0.108

Electrical Characteristics ($T_A=25^{\circ}\text{C}$ unless otherwise noted)

Part Number(Uni)	Part Number(Bi)	Breakdown Voltage $V_{BR}@I_T$			Maximum Reverse Leakage I_R @ V_{WM} (μA)	Working Peak Reverse Voltage V_{RWM} (V)	Maximum Reverse Surge Current IPP (A)	Maximum Clamping Voltage V_c @ I_{PP} (V)	Maximum Temperature Coefficient of V_{BR} (%/ $^{\circ}\text{C}$)
		Min(V)	Max (V)	I_T (mA)					
P4KE200	P4KE200C	180	220	1	1	162	1.4	287	0.108
P4KE200A	P4KE200CA	190	210	1	1	171	1.5	274	0.108
P4KE220	P4KE220C	198	242	1	1	175	1.2	344	0.108
P4KE220A	P4KE220CA	209	231	1	1	185	1.2	328	0.108
P4KE250	P4KE250C	225	275	1	1	202	1.1	360	0.110
P4KE250A	P4KE250CA	237	263	1	1	214	1.2	344	0.110
P4KE300	P4KE300C	270	330	1	1	243	0.93	430	0.110
P4KE300A	P4KE300CA	285	315	1	1	256	1	414	0.110
P4KE350	P4KE350C	315	385	1	1	284	0.79	504	0.110
P4KE350A	P4KE350CA	333	368	1	1	300	0.83	482	0.110
P4KE400	P4KE400C	360	440	1	1	324	0.7	574	0.110
P4KE400A	P4KE400CA	380	420	1	1	342	0.73	548	0.110
P4KE440	P4KE440C	396	484	1	1	356	0.63	631	0.110
P4KE440A	P4KE440CA	418	462	1	1	376	0.66	602	0.110
P4KE480	P4KE480C	432	528	1	1	389	0.58	686	0.110
P4KE480A	P4KE480CA	456	504	1	1	408	0.61	658	0.110
P4KE510	P4KE510C	459	561	1	1	413	0.55	729	0.110
P4KE510A	P4KE510CA	485	535	1	1	434	0.57	698	0.110
P4KE540	P4KE540C	486	594	1	1	437	0.52	772	0.110
P4KE540A	P4KE540CA	513	567	1	1	459	0.54	740	0.110
P4KE550	P4KE550C	495	605	1	1	470	0.51	786	0.110
P4KE550A	P4KE550CA	522	577	1	1	467	0.53	760	0.110

Typical Characteristics

FIG1: Peak Pulse Power Rating Curve

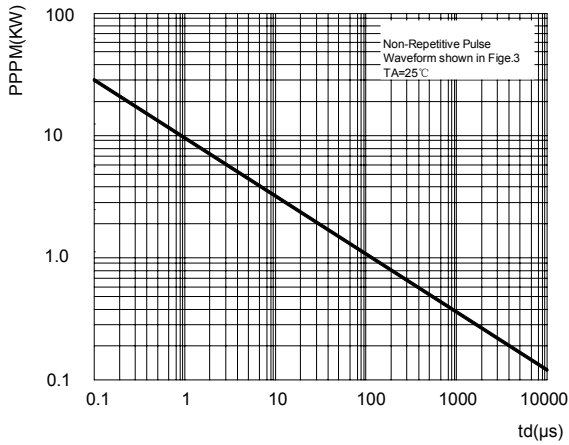

FIG2: Pulse Power or Current vs. Initial Junction Temperature

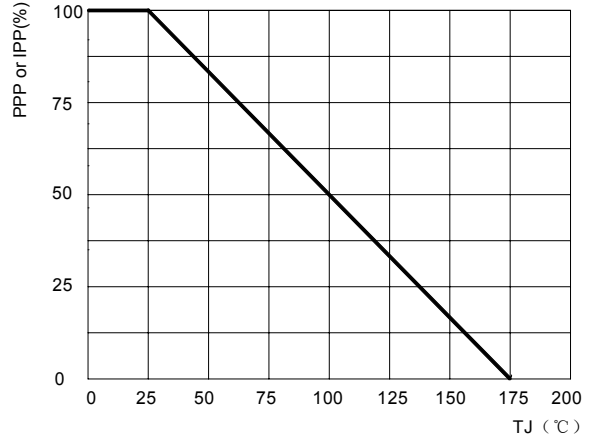

FIG3: Pulse Waveform

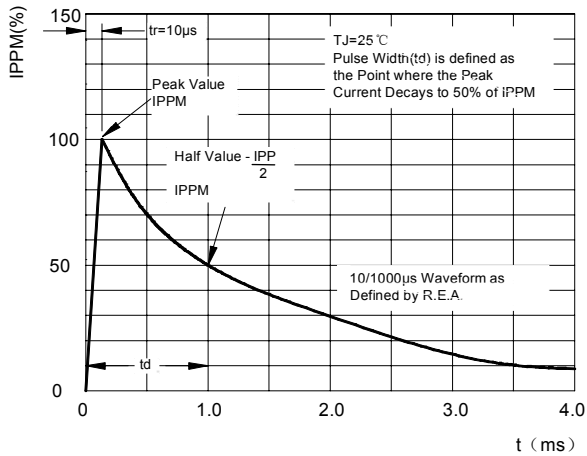

FIG4: Power Derating Curve

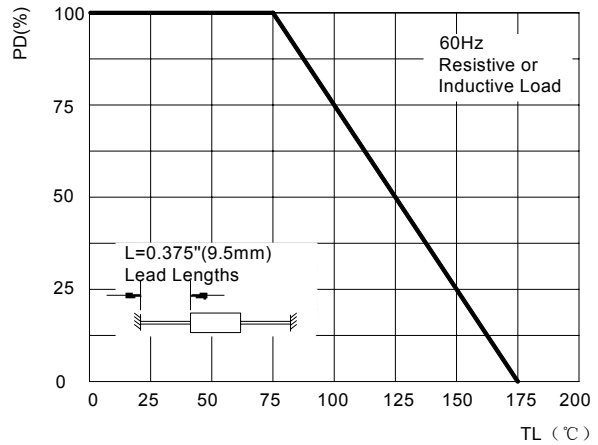

FIG5: Maximum Non-Repetitive Surge Current

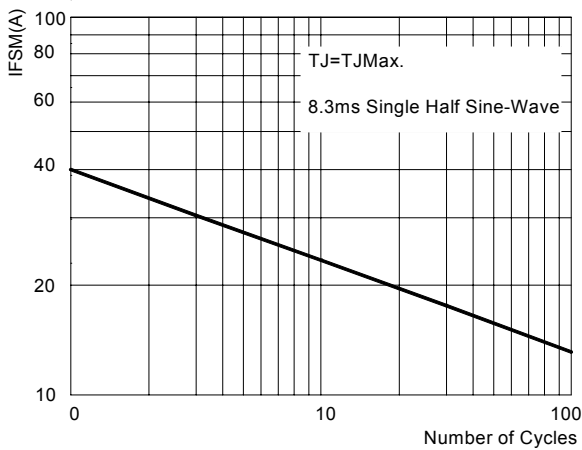
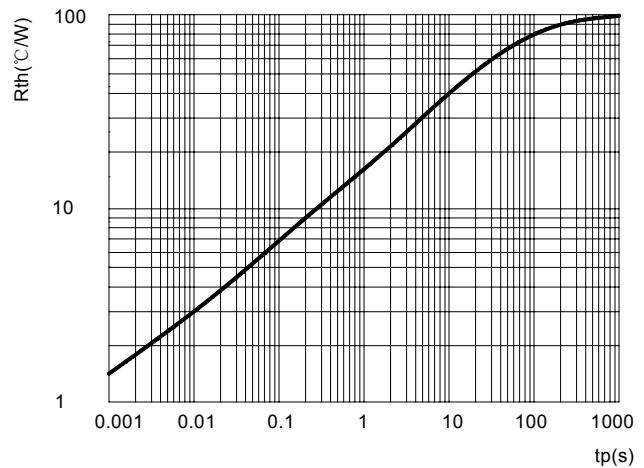
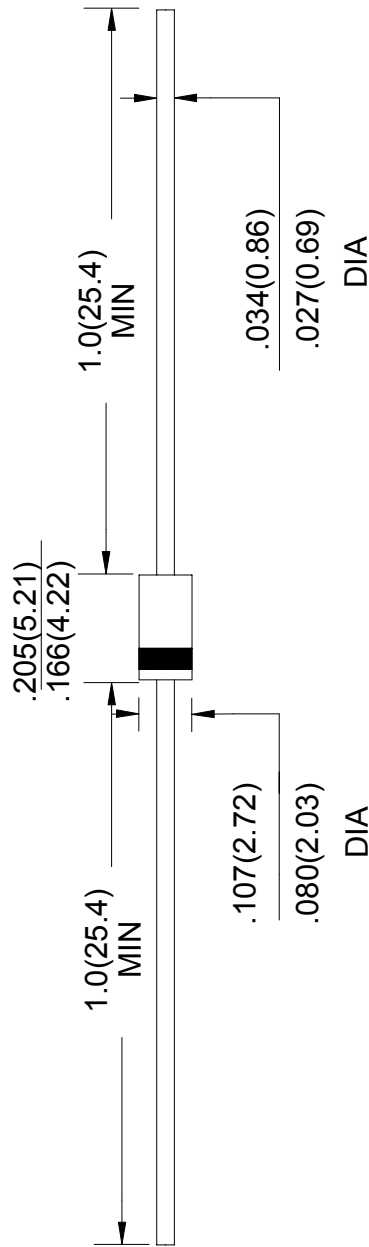

FIG6: Typical Transient Thermal Impedance





Unit: in inches (millimeters)

NOTICE

JSCJ reserves the right to make modifications, enhancements, improvements, corrections or other changes without further notice to any product herein. JSCJ does not assume any liability arising out of the application or use of any product described herein.

Ammo Box Packaging Specifications For Axial Lead Rectifiers

Axial lead devices are packed in accordance with EIA standard RS-296-D and specifications given below

COMPONENT OUTLINE	COMPONENT PITCH A	INNER TAPE PITCH B	CUMULATIVE PITCH TOLERANCE
	$\pm 0.5\text{mm}(.020'')$	$+0.5\text{mm}(.020'')$	
R-1	5.0mm	26.0mm	2.0mm/20pitch
R-1	5.0mm	52.4mm	2.0mm/10pitch
A-405	5.0mm	26.0mm	2.0mm/20pitch
A-405	5.0mm	52.4mm	2.0mm/10pitch
DO-34/DO-35	5.0mm	26.0mm	2.0mm/20pitch
DO-34/DO-35	5.0mm	52.4mm	2.0mm/10pitch
DO-41	5.0mm	26.0mm	2.0mm/20pitch
DO-41	5.0mm	52.4mm	2.0mm/10pitch
DO-15	5.0mm	52.4mm	2.0mm/10pitch
DO-27	10.0mm	52.4mm	2.0mm/10pitch
R-6	10.0mm	52.4mm	2.0mm/10pitch

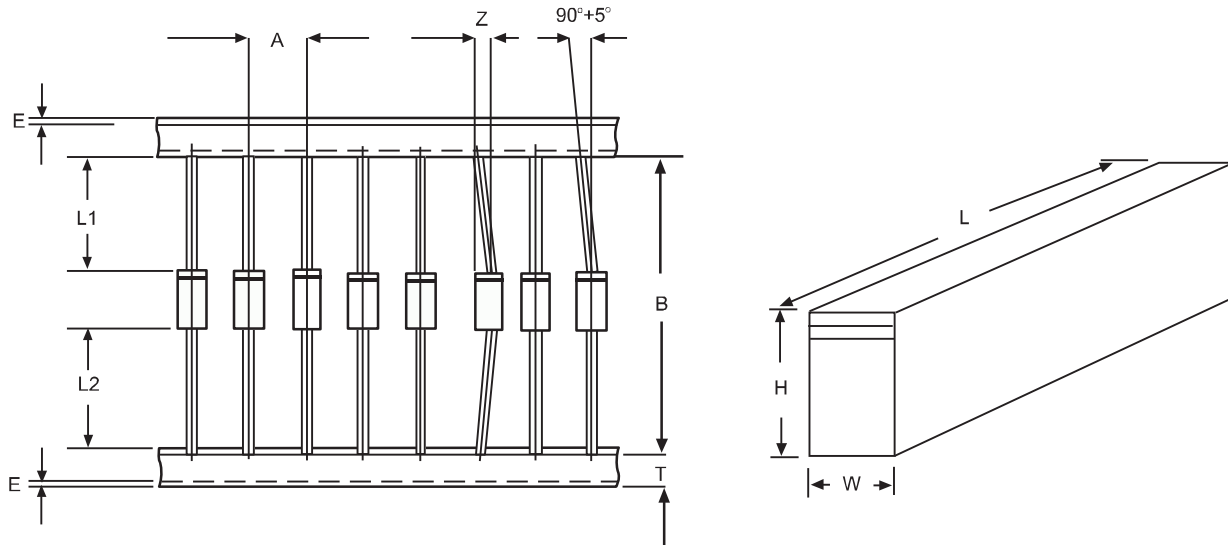

ITEM	SYMBOL	SPECIFICATIONS(mm)	SPECIFICATIONS(inch)
Component alignment	Z	1.2max	0.048max
Tape width	T	6.0 ± 0.4	0.236 ± 0.016
Exposed adhesive	E	0.8max	0.032max
Body eccentricity	$ L1-L2 $	1.0max	0.040max
Box length	L	255.0 ± 5.0	10.04 ± 0.197
Box width	W	78.0 ± 5.0	3.07 ± 0.197
Box height	H	150.0 ± 5.0	5.91 ± 0.197

NOTE: Each component lead shall be sandwiched between tapes for A minimum of 3.2mm(0.126'')