

NEW

75Ω Micro Coaxial Connector Supporting 12G-SDI

D.FL75 Series

75Ω, up to 12GHz



Exterior mating view

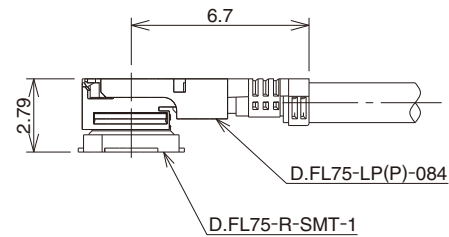

Fig.1

Features

1. Compact 75Ω Coaxial Connector

Receptacle and plug (right angle) produces a total mating height of only 2.79mm. (Fig. 1)

2. High impedance matching

High frequency compatible from DC to 12GHz suitable for 12G-SDI broadcasting equipment.

3. Terminated with 75Ω, ultra-fine coaxial cable

φ1.5mm, ultra-fine coaxial (flourinated resin insulated) cables allow for connections in limited spaces.

4. Suitable for 12G-SDI broadcasting and video equipment

When used with the BNC(75) series plug, 75Ω system lines are maintained from interface connection to the internal wiring systems.

5. Supports automatic mounting

Tape and Reel packaging allows for pick-and-place mounting.

6. Easy mating

Compact connector makes a clear tactile click when mated which confirms complete mating.

7. Simple unmating process

An extraction tool which simplifies the unmating process is available.

8. Environmental Compatibility

◆Halogen Free

Chlorine and bromine above the standard values are not used for receptacle and plug harnesses.

*As defined by IEC61249-2-21

Br-900 ppm maximum, Cl-900 ppm maximum, Cl+Br combined-1,500 ppm maximum

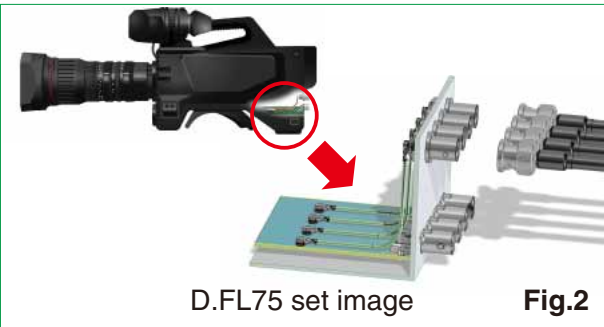

D.FL75 set image

Fig.2

Applications

Broadcasting camera, FA/commercial camera, switcher, medical equipment, large video equipment.

Function Diagram

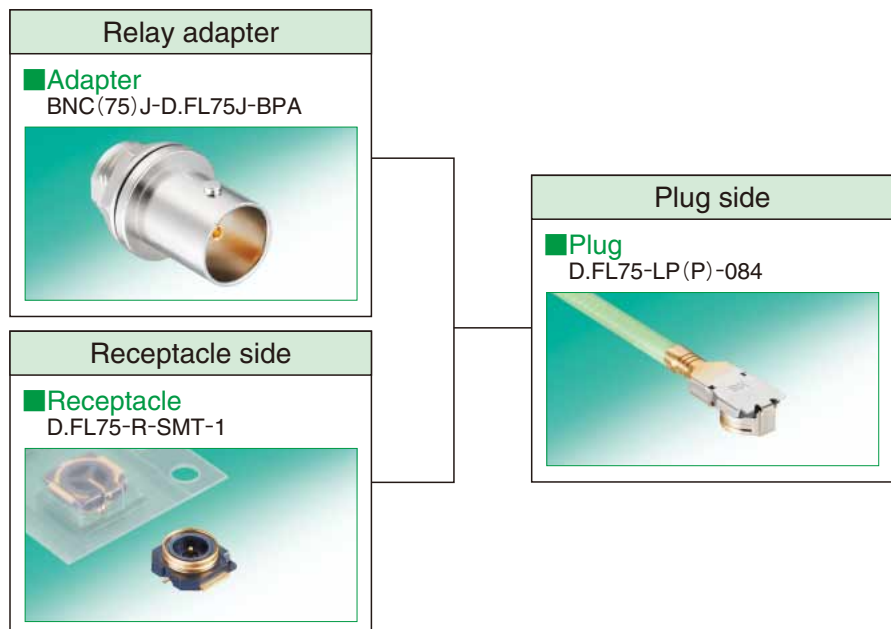

Product Specifications

Ratings	Nominal characteristic impedance : 75Ω	Operating temperature range	-40°C to +105°C (RH 90% max.)
	Frequency range : DC to 12GHz	Storage temperature range	-20°C to +70°C (RH 90% max.)

Items	Specifications	Conditions
1. Contact resistance	Center : 50mΩ max. Outer : 20mΩ max.	Measured with 10mA max.
2. Insulation resistance	500MΩ min.	Measured with 250V DC
3. Withstanding voltage	No flashover or insulation breakdown	300V AC for 1 min.
4. V.S.W.R. (*)	1.3 max.	DC to 3GHz
	1.5 max.	3 to 12GHz
5. Total Insertion/ Extraction Force	Insertion force 30N max.	Measured with applicable connector
	Extraction force First time : 7N min. 2 to 20 times : 3N min.	
6. Durability (insertion/ extraction with corresponding plug)	Contact resistance Center : 55mΩ max. Outer : 25mΩ max.	20 mating cycles
7. Vibration resistance	No electrical discontinuity for 1μs or more. No damaged, cracks or loose parts.	Frequency of 10 to 100Hz, single amplitude of 1.5mm, acceleration of 59m/s ² , for 5 cycles in 3 axial directions.
8. Shock resistance	No electrical discontinuity for 1μs or more. No damaged, cracks or loose parts.	Acceleration of 735m/s ² , for a duration of 11 ms, sine half-wave waveform, 3 cycles in 6 axial directions.
9. Humidity resistance (Steady state)	Insulation resistance : 10MΩ min. (high humidity) Insulation resistance : 500MΩ min. (dry) No damaged, cracked or loose parts.	96 hours at temperature of 40°C and humidity of 95%
10. Temperature cycle	No damaged, cracked or loose parts.	Temperature : -40°C → +5 to +35°C → +105°C → +5 to +35°C Time : 30 → 5 max. → 30 → 5 max. (minutes) 5 Cycles
11. Salt spray	Meets voltage standing wave ratio (V.S.W.R.) standards	5% salt water solution for 48 consecutive hours

*V.S.W.R. Measurement System

The above V.S.W.R. specification values were measured using the measurement system shown below.

Plug harness measurement system

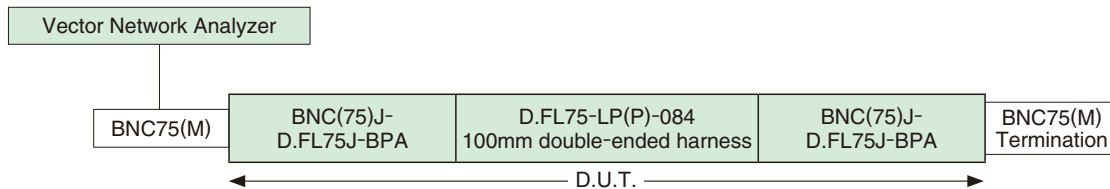

Receptacle measurement system

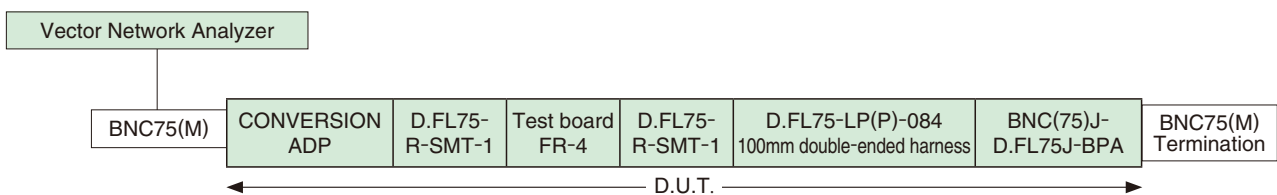

Materials / Finish

Product	Part	Materials	Finish/Remarks
Plug-right angle	Shell	Phosphor bronze	Partially gold plated
	Insulator	LCP	Black, UL94V-0
	Female center contact	Phosphor bronze	Gold plated
Receptacle	Shield	Phosphor bronze	Gold plated
	Insulator	LCP	Black, UL94V-0
	Male center contact	Phosphor bronze	Gold plated
Adapter	Shell	Brass/zinc alloy	Nickel plated
	Insulator	PTFE resin	—
	Male center contact	Phosphor bronze	Gold plated

Plug

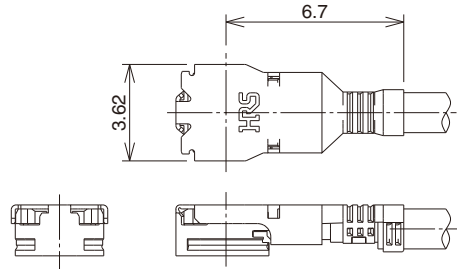

[Please order plug with as cabled assembly]

How to Specify Plug Cable Assembly

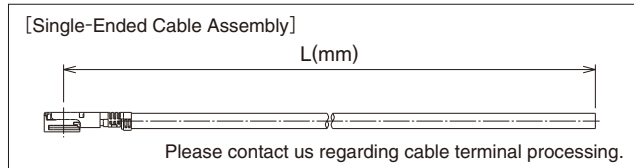
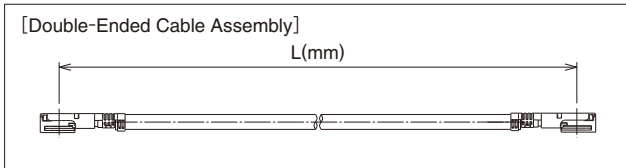

Cable Assembly Product Number Structure

Refer to this page when determining product specifications by model types. Please place orders with part numbers listed in this catalog. The characteristics and specifications of the product described in this catalog are reference values. Please make sure to check the latest delivery specifications at the time of product use.

DFL75 - 2LPP - 084N 9 D - [] - L

① ② ③ ④ ⑤ ⑥ ⑦

① Series name : D.FL75	⑤ Cable exterior conductor specifications D : Copper tape+exterior single braid
② Assembly type 2LPP : Double-ended	⑥ Connector direction (double-ended) A : Same direction AC : Reversed 180°
③ Cable type 084N : φ1.5mm cable	⑦ Total Length L L length (mm)
④ Cable color 9 : Green	

Standard Tolerances for L

Total length (mm)	Standard Tolerance (mm)
$50 \leq L \leq 200$	±4
$200 < L \leq 500$	±8
$500 < L \leq 1000$	±12
$1000 < L$	±1.5%

Note : 50mm is the shortest length (L) that can be made.

Receptacle

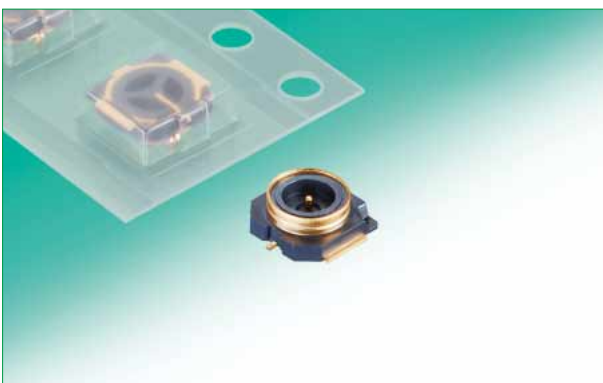

Recommended PC Board Pattern/ Metal Mask Drawing

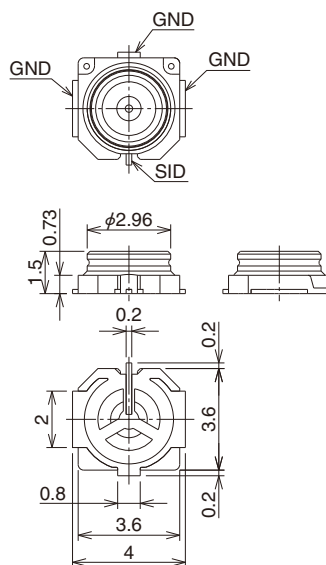

Recommended PC Board Pattern Drawing

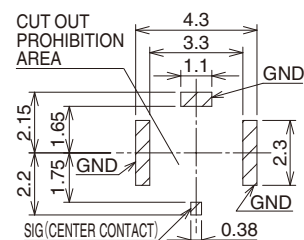

Recommended Metal Mask Drawing

Thickness : 0.10mm/0.12mm

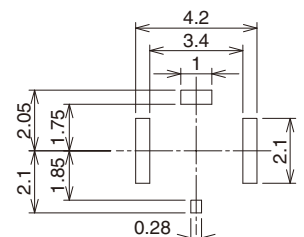

Part No.	HRS No.	Packaging	Mass (g)
D.FL75-R-SMT-1(01)	331-0079-0 01	100 pieces per pack	0.031/pc
D.FL75-R-SMT-1(40)	331-0079-0 40	5,000 pieces per reel	

● Embossed Carrier Tape Dimensions (JIS-C-0806 / IEC60286 compliant)

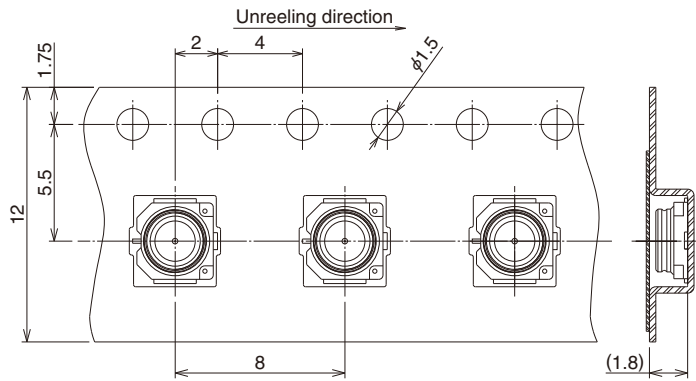

● Reel Dimensions

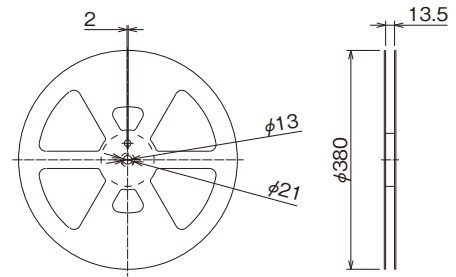

The above diagram shows the embossed carrier tape dimensions used to package D.FL75-R-SMT-1(40).

■ Conversion Adapter

● BNC(75) Conversion Adapter (Mating portion-D.FL75 side : Jack, BNC(75) jack)

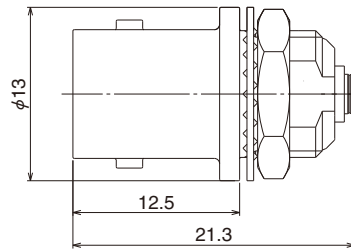

Panel mounting hole dimensions

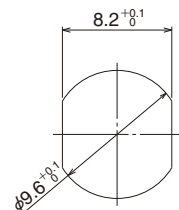

Recommended thickness / dimensions : 0.8-2.7mm

Part No.	HRS No.	Mass (g)
BNC(75)J-D.FL75J-BPA	311-0015-0	5.66/pc

■ Plug Extraction Tool

Recommended unmating tool the plug.

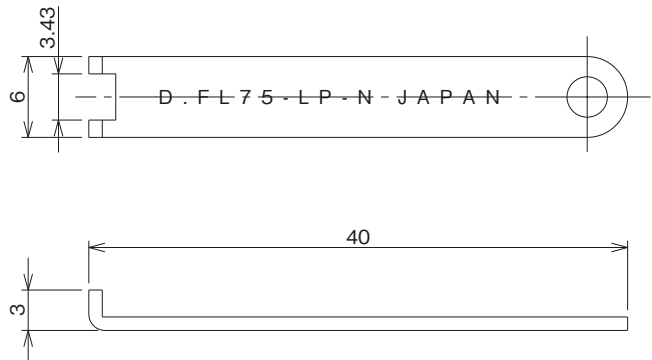

Part No.	HRS No.	Mass (g)
D.FL75-LP-N	311-0080-0	1.85/pc

There is a possibility of deforming / damaging the plug extraction tool when dropped, etc., please handle with care.

◆ Usage Precautions

1. Plugs

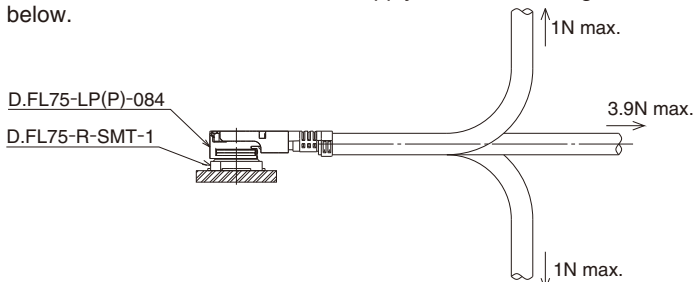
(1) Mating/Unmating	<ol style="list-style-type: none"> To disconnect the connector, insert the extraction tool (D.FL75-LP-N) under the connector flange. Pull in a perpendicular direction in line with the connector's mating axis. Do not unmate the plug by pulling on the cable, this can damage the connector performance. When mating, align the mating axes between the receptacle and cable assembly, and insert the cable assembly downward and perpendicular into the receptacle. Do not insert the cable assembly at a slanted angle.
(2) Tolerable load to a cable after mating	<p>Once the connector has been mated do not apply forces exceeding the values in the diagram below.</p> 
(3) Precautions	Do not use excessive prying form to mate or un-mate the connectors as it may lead to damage.

2. Receptacles

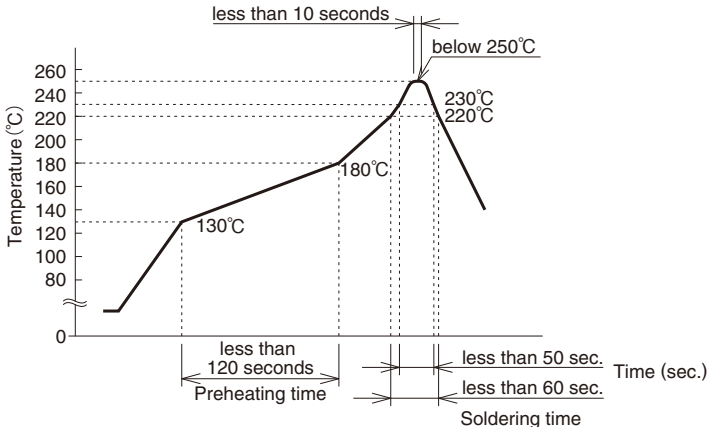
(1) Recommended reflow temperature profile (reference)	<p style="text-align: center;">Lead-free paste solder temperature profile (reference)</p>  <ol style="list-style-type: none"> The temperatures indicated are the surface temperatures of the printed circuit board near the terminal contact points. Reflow soldering should be performed on the surface of the printed circuit board at a max temperature of 250°C or less. Temperature profile may vary due to external mounting conditions such as solder paste, manufacturer, PCB size and other soldering materials.
(2) Recommended metal mask thickness	0.1mm-0.12mm
(3) Reflow cycles	Maximum of 2 cycles

3. Operating Environment and Storage Conditions

(1) Operation environment	<p>This product was designed assuming use in a normal environment. Please be advised that using this product in the environments described below may result in discoloration and other types of degradation.</p> <ul style="list-style-type: none"> •Exposure to excessive amounts of fine particles and dust. •Regions/ areas with a high concentration of gases like sulfur dioxide, hydrogen sulfide and nitrogen dioxide. •Areas with drastic temperature change, such as locations near a heater.
(2) Storage conditions	<p>Store this product in Hirose's packaging or similar conditions. Temperature : -10 to +40°C Humidity : 85% or less (recommended storage conditions) We recommend the product be used within six months from delivery. Products that have been stored beyond the recommended storage period need to be tested for mounting and solderability before use.</p>

High Frequency Characteristics of related 75Ω, 12G-SDI Hirose products

● D.FL75 Series

◆ Plug assembly High-frequency characteristics

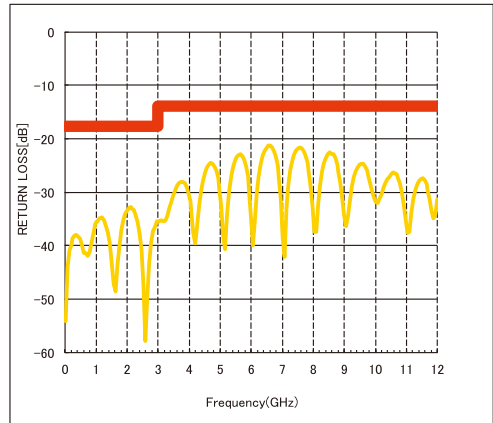
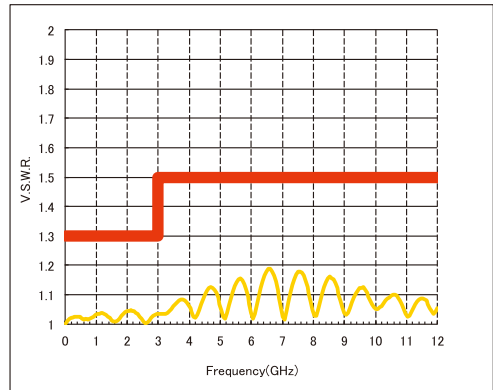
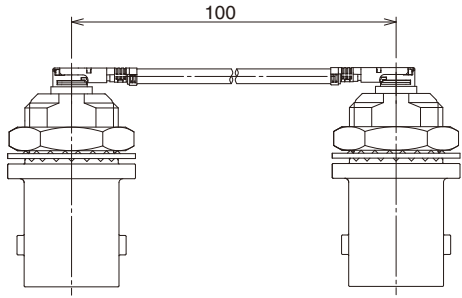

◆ Receptacle High-frequency Characteristics

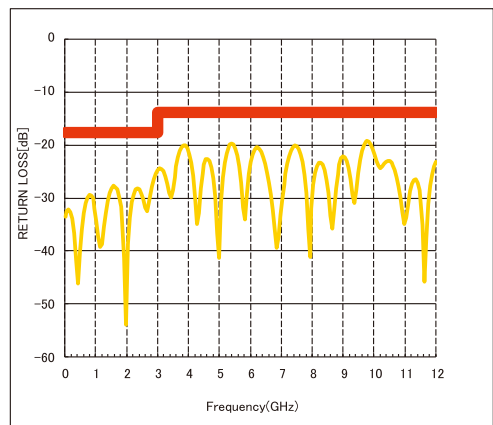
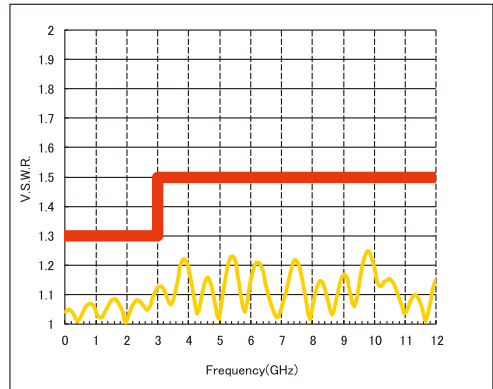
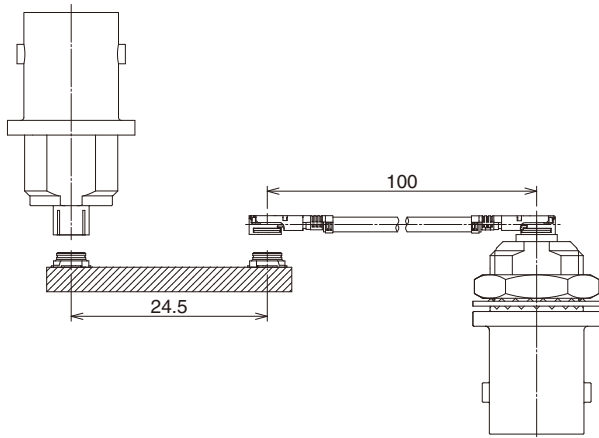

Please refer our BNC(75) series when mounting a BNC receptacle directly on to the board.

■12G-SDI standard compatible BNC(75) connector

12G (UHD)-SDI (SMPTE ST-2082) transmission compatible.

Meets 12G-SDI standard while maintaining superior reflection characteristics.

■Right angle receptacle

●Center contact THR type, 16mm minimum PCB mount pitch

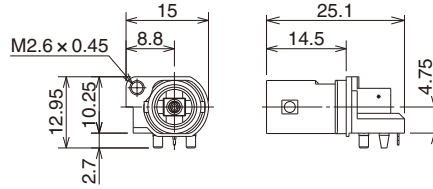

Part No.	HRS No.	Mass (g)
BNC(75)-PLR-PC(D)-12G-3	302-0088-0	5.3/pc

●Center contact SMT type, 16mm minimum PCB mount pitch

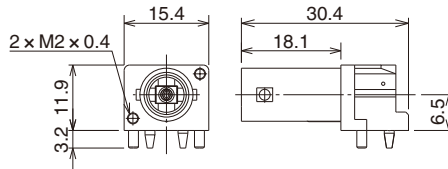

Part No.	HRS No.	Panel mount	Minimum PCB mount pitch	Mass (g)
BNC(75)-PLR-PC-12G-2	302-0085-0	Screw : M2×0.4	16mm	9.4/pc

●Center contact SMT type

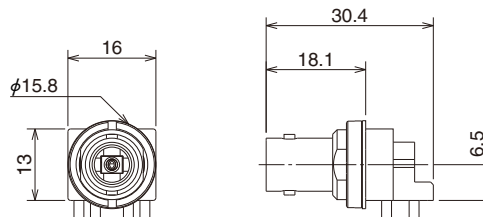
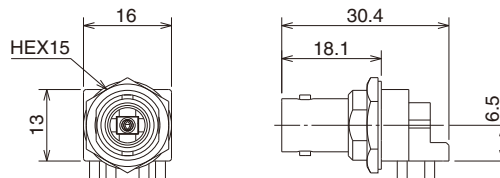
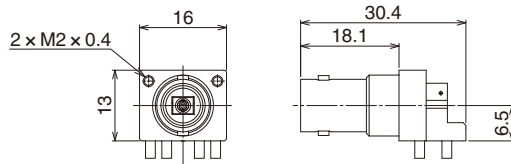

Part No.	HRS No.	Panel mount	Minimum PCB mount pitch	Mass (g)
BNC(75)-PLR-PC-12G-1	302-0083-0	Screw : M2×0.4	17mm	13.6/pc
BNC(75)-BLR-PC-12G	302-0081-0	Nut : HEX15	17.5mm	
BNC(75)-BLR-PC-12G(01)	302-0081-0 01	Nut : φ15.8	16.5mm	

■ Straight receptacle

● Center contact THR type, 16mm minimum PCB mount pitch

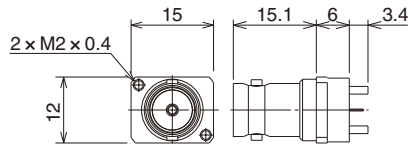

Part No.	HRS No.	Panel mount	Minimum PCB mount pitch	Mass (g)
BNC(75)-PR(6)-PC-12G	302-0086-0	Screw : M2×0.4	16mm	9.65/pc

■ Plug

● Straight crimp type

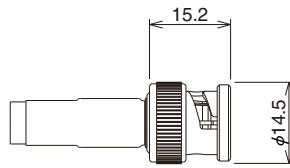

Part No.	HRS No.	Applicable cable	Mass (g)
BNC(75)-P-5.5C-12G	302-0091-0	5.5C-UHD/FW	11.65/pc
BNC(75)-P-3.3C-12G	302-0092-0	3.3C-UHD/FW	11.6/pc

◆ Plug assembly High-frequency characteristics

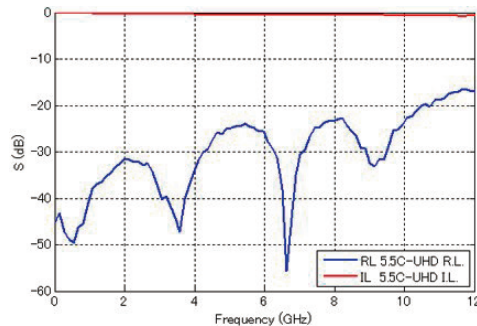
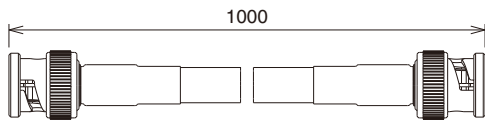

◆ Receptacle High-frequency characteristics

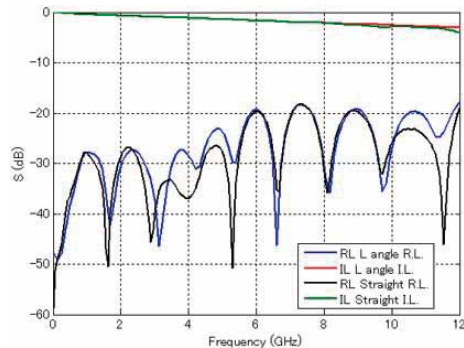
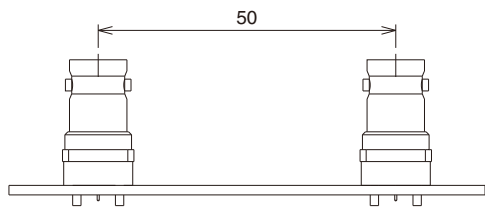

HIROSE ELECTRIC CO.,LTD.

2-6-3,Nakagawa Chuoh,Tsuzuki-Ku,Yokohama-Shi 224-8540,JAPAN

TEL: +81-45-620-3526 Fax: +81-45-591-3726

<http://www.hirose.com>

<http://www.hirose-connectors.com>