

EGP15A thru EGP15G

Glass Passivated Junction Ultra Fast Rectifiers

Reverse Voltage 50 to 1000V

Forward Current 1.5A

1.FEATURES

- * Plastic package has Underwriters Laboratory Flammability Classification 94V-0
- * High temperature metallurgically bonded construction
- * Cavity-free glass passivated junction
- * Capable of meeting environmental standards of MIL-S-19500
- * For use in high frequency rectifier circuits
- * Fast switching for high efficiency
- * High temperature soldering guaranteed: 260°C/10 seconds
- * 0.375" (9.5mm) lead length, 5 lbs. (2.3kg) tension

2.Mechanical Data

Case: JEDEC DO-15, molded plastic over glass body

Terminals: Plated axial leads, solderable per MIL-STD-750, Method 2026

Polarity: Color band denotes cathode end

Mounting Position: Any

Weight: 0.015 oz., 0.41 g

Handling precaution:None

3.Electrical Characteristic

Maximum Ratings & Thermal Characteristics Ratings at 25°C ambient temperature unless otherwise specified.

Parameter Symbol	symbol	EGP 15A	EGP 15B	EGP 15C	EGP 15D	EGP 15F	EGP 15G	EGP 15J	EGP 15K	EGP 15M	Unit
Maximum repetitive peak reverse voltage	V_{RRM}	50	100	150	200	300	400	600	800	1000	V
Maximum RMS voltage	V_{RMS}	35	70	105	140	210	280	420	560	700	V
Maximum DC blocking voltage	V_{DC}	50	100	150	200	300	400	600	800	1000	V
Maximum average forward rectified current 0.375" (9.5mm) lead length at TA = 55°C	IF(AV)	1.5									A
Peak forward surge current 8.3ms single half sine-wave superimposed on rated load (JEDEC Method)	I_{FSM}	50						45			A
Typical thermal resistance (Note 2)	RθJA	40									°C/W
Operating junction and storage temperature range	TJ, TSTG	-50to +150									°C

We declare that the material of product compliance with RoHS requirements.

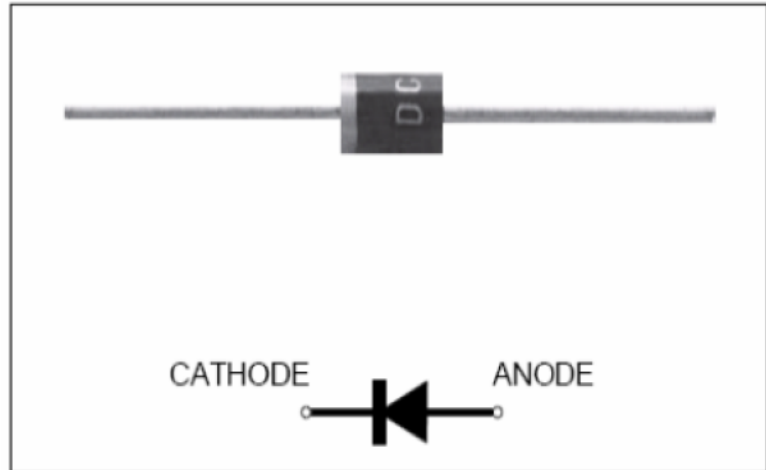

Electrical Characteristics Ratings at 25°C ambient temperature unless otherwise specified.

Parameter Symbol	symbol	EGP 15A	EGP 15B	EGP 15C	EGP 15D	EGP 15F	EGP 15G	EGP 15J	EGP 15K	EGP 15M	Unit
Maximum Instantaneous Forward Voltage (IF = 1.5 Amps, TJ = 25°C)	V_F	1.00				1.25		1.70			V
Maximum full load reverse current, full cycle average, 0.375" (9.5mm) lead lengths (Rated dc Voltage, TJ = 25°C) (Rated dc Voltage, TJ = 125°C)	IR	5.0 200									μA
Typical reverse recovery time (Note 1)	trr	50						75			ns
Typical junction capacitance at 4.0V, 1MHz	CJ	35									PF

NOTES:

1. IF = 0.5A, IR = 1.0A, IRR = 0.25A
2. Thermal resistance from junction to ambient at 0.375" (9.5mm) lead length, P.C.B. mounted

Ratings and Characteristic Curves (TA = 25°C unless otherwise noted)

Fig. 1 - Forward Current Derating Curve

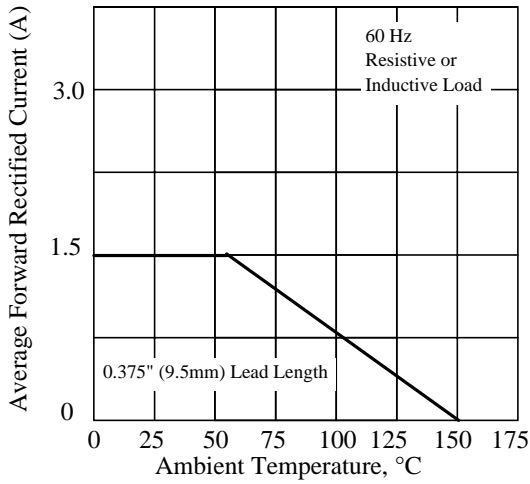

Fig. 2 - Maximum Non-repetitive Peak Forward Surge Current

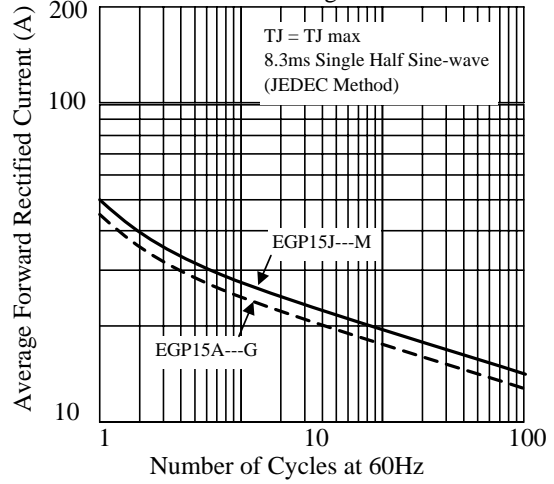

Fig. 3 - Typical Instantaneous Forward Characteristics

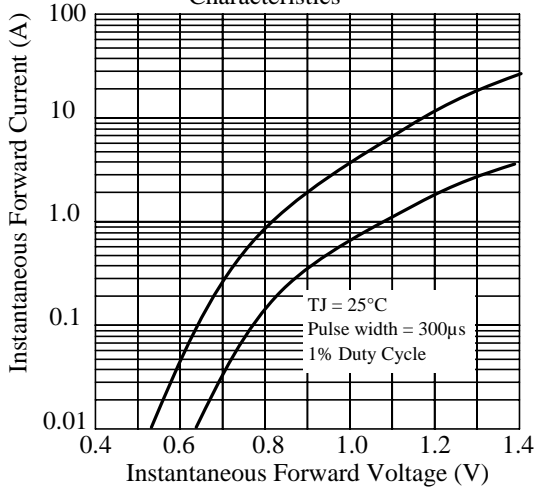

Fig. 4 - Typical Reverse Characteristics

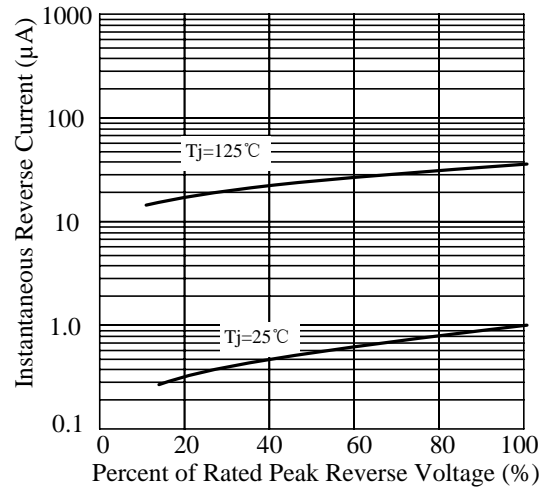

Fig. 5 - typical transient thermal impedance

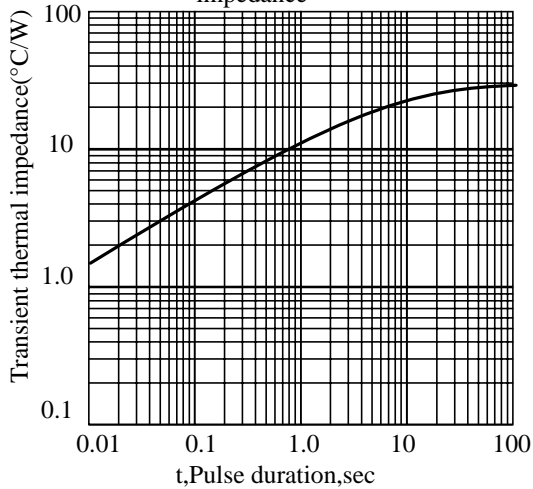
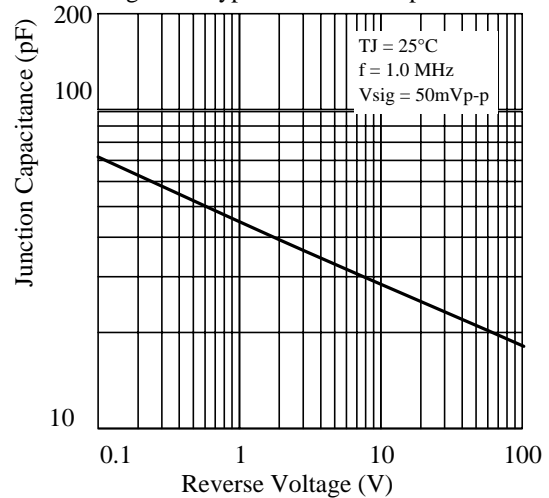
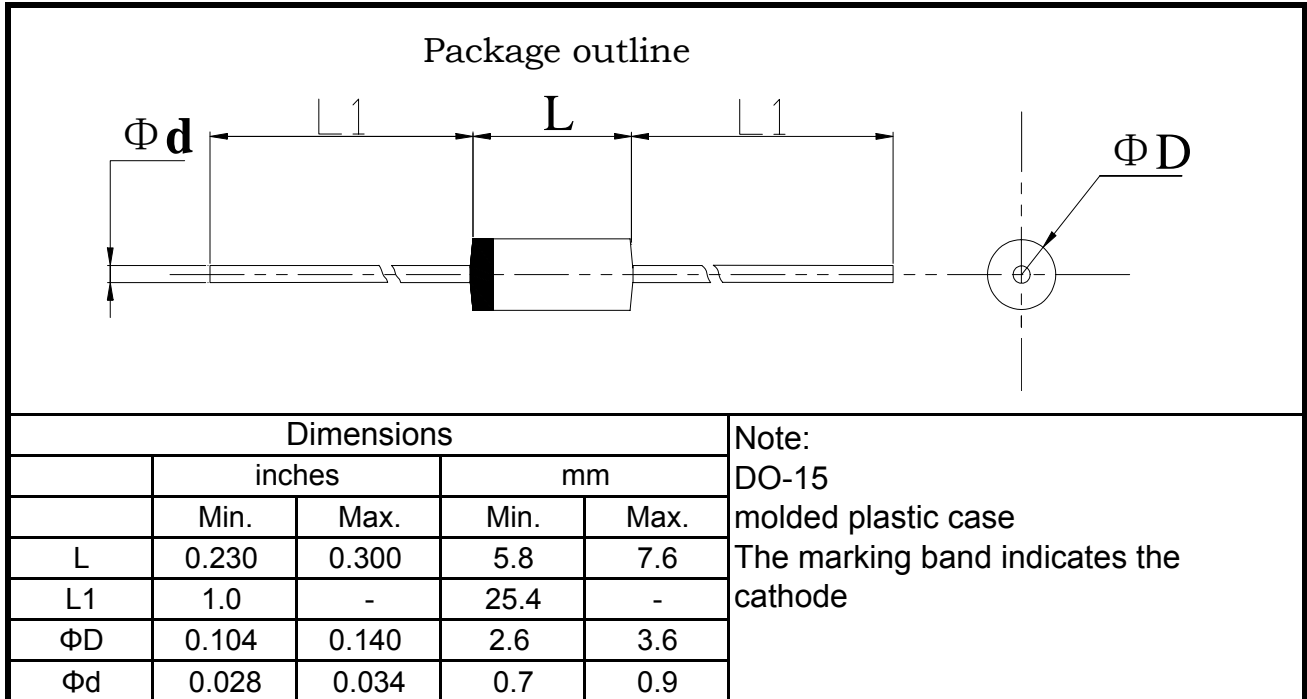

Fig. 6 - Typical Junction Capacitance



5.Package Dimensions in inches and (millimeters)

Packing Of Plastic-Sealed Axial Lead Diodes

1. 卷盘/Reel Packing (52mm)

A: 卷盘规格/Reel spec.



Unit:mm

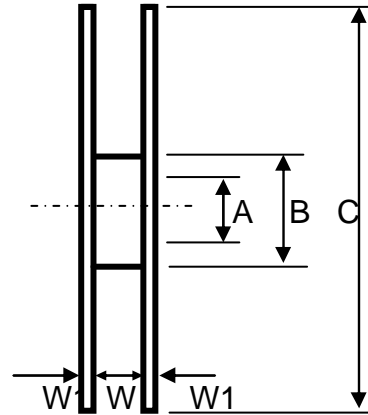

Item	Symbol	Dimension
Dimeter	A	76.4±0.1
	B	82.5±0.2
	C	330±0.5
Width	W	72±0.2
Thickness	W1	3±0.2

B: 外箱规格/Outer Box Specification

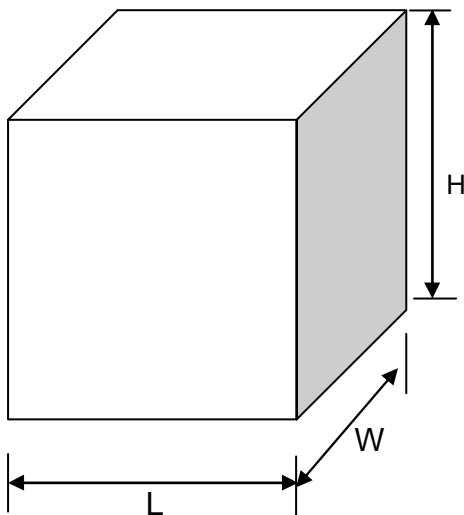

Item	Symbol	Dimension
Size	L	350±2
	W	350±2
	H	340±4

按以上包装方式: (As per the above spec)

	外型/Outside		
	DO-41 & A-405	DO-15	DO-201AD
Q'ty/Taping	5K	4K	1.4K
Q'ty/Packing Case	20K	16K	5.6K

2. 弹带盒装/Ammo Packing

Unit:mm

A: 弹带盒规格/Ammo Box Spec.



Item	Symbol	Dimension	Notes
Box's Size	L	260±2	52mm TYPE
	W	76±2	
	H	100±4	
	L	250±3	26mm TYPE
	W	45±3	
	H	95±5	

B: 外箱规格/Outer Box Specification

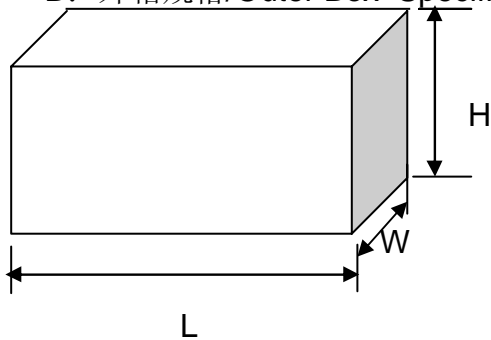

Item	Symbol	Dimension	Notes
Case's Size	L	430±2	52mm TYPE
	W	280±2	
	H	225±4	
	L	435±3	26mm TYPE
	W	280±3	
	H	295±5	

按以上包装方式: (As per the above spec)

	外型/Outside		
	A-405 & DO-41 & R-1	DO-15	DO-201AD
Q'ty/Taping	3K	2K	0.8K
Q'ty/Packing Case 26mm/TYPE	30K	20K	7.2K
Q'ty/Packing Case 52mm/TYPE	60K	40K	14.4K

3. 散装/Bulk Packing

A. 包装盒尺寸/Box Dimension

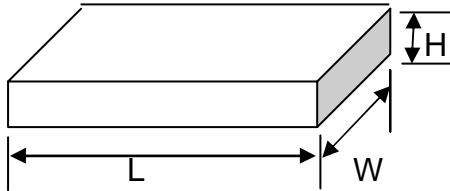

(DO-41&DO-15)

Item	Symbol	Dimension
Box's Size	L	200±2
	W	84±2
	H	21±2

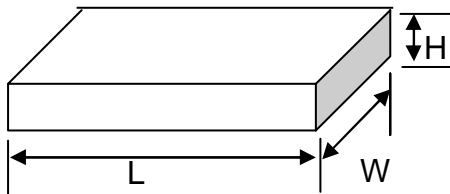

(DO-201AD)

Item	Symbol	Dimension
Box's Size	L	200±2
	W	84±2
	H	29±2

B: 外箱规格/Outer Box Specification

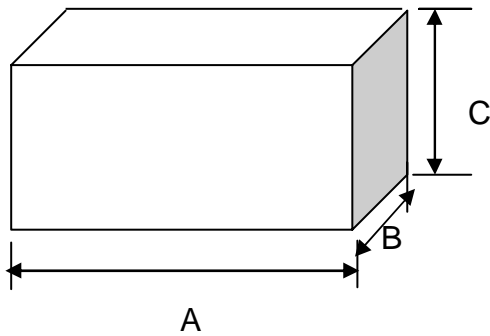

Item	Symbol	Dimension
Case's Size	L	465±2
	W	225±2
	H	260±4

按以上包装方式: (As per the above spec)

	外型/Outside		
	DO-41&A-405&R-1	DO-15	DO-201AD
Q'ty/Taping	1K	0.5K	0.3K
Q'ty/Packing Case	50K	25K	12K

4. 编带图形及规格/Taping Specification

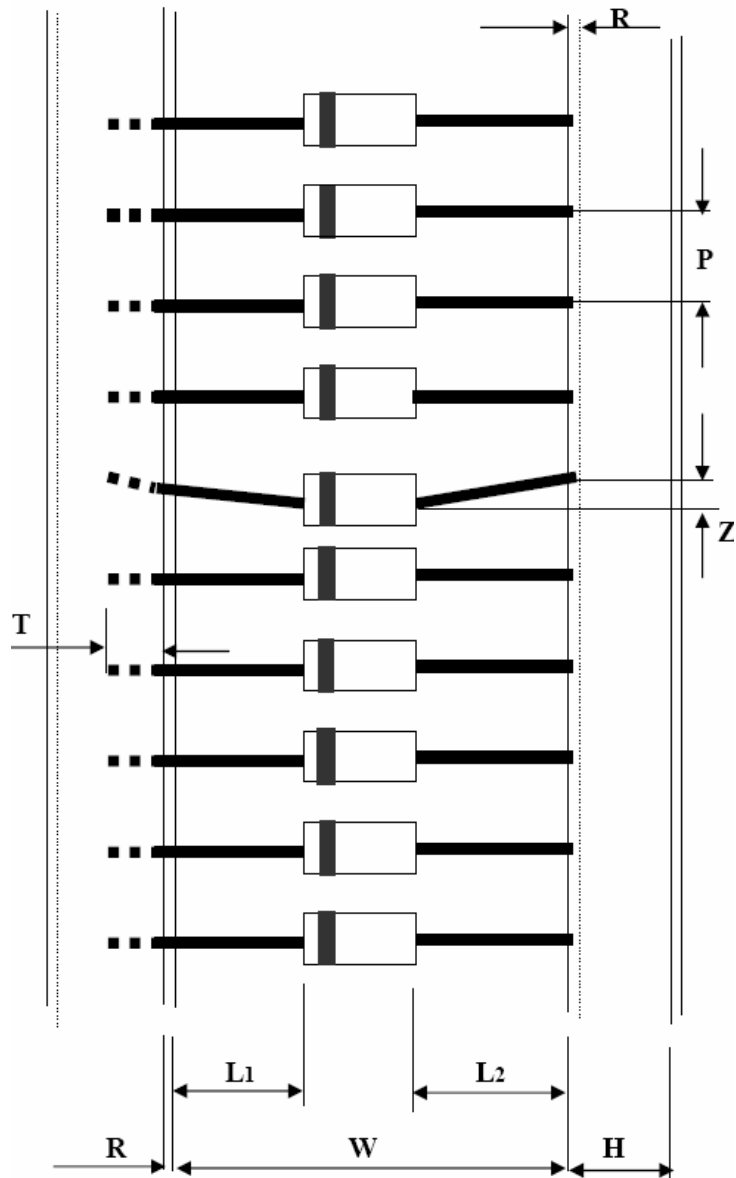

Unit:mm

尺寸代号	编带尺寸/Tape Dimension		
Dimension Code	26/tape	52/tape	52/tape#
W	26 0.0/+1.6	52 -1.0/+2.0	52 -1.0/+2.0
P	5±0.5	5±0.5	10±0.5
L1-L2	<1.0	<1.2	<1.2
H	6±1.0	6±1.0	6±1.0
Z	<1.2	<1.2	<1.2
R	<1.0	<1.0	<1.0
T	>3.2	>3.2	>3.2

注：52编带# 为DO-201AD编带规格

Remark: 52 tape# is DO-201AD taping spec.